



# User's Manual

## 1200Mbps 11ac Dual Band Ceiling Mount Wireless AP

▶ WDAP-C7200AC/WDAP-W7200AC



## Copyright

Copyright © 2015 by PLANET Technology Corp. All rights reserved. No part of this publication may be reproduced, transmitted, transcribed, stored in a retrieval system, or translated into any language or computer language, in any form or by any means, electronic, mechanical, magnetic, optical, chemical, manual or otherwise, without the prior written permission of PLANET.

PLANET makes no representations or warranties, either expressed or implied, with respect to the contents hereof and specifically disclaims any warranties, merchantability or fitness for any particular purpose. Any software described in this manual is sold or licensed "as is". Should the programs prove defective following their purchase, the buyer (and not PLANET, its distributor, or its dealer) assumes the entire cost of all necessary servicing, repair, and any incidental or consequential damages resulting from any defect in the software. Further, PLANET reserves the right to revise this publication and to make changes from time to time in the contents hereof without obligation to notify any person of such revision or changes.

All brand and product names mentioned in this manual are trademarks and/or registered trademarks of their respective holders.

## Federal Communication Commission Interference Statement



This equipment has been tested and found to comply with the limits for a Class B digital device, pursuant to Part 15 of FCC Rules. These limits are designed to provide reasonable protection against harmful interference in a residential installation. This equipment generates, uses, and can radiate radio frequency energy and, if not installed and used in accordance with the instructions, may cause harmful interference to radio communications. However, there is no guarantee that interference will not occur in a particular installation. If this equipment does cause harmful interference to radio or television reception, which can be determined by turning the equipment off and on, the user is encouraged to try to correct the interference by one or more of the following measures:

1. Reorient or relocate the receiving antenna.
2. Increase the separation between the equipment and receiver.
3. Connect the equipment into an outlet on a circuit different from that to which the receiver is connected.
4. Consult the dealer or an experienced radio technician for help.

## FCC Caution

To assure continued compliance, use only shielded interface cables when connecting to computer or peripheral devices. Any changes or modifications not expressly approved by the party responsible for compliance could void the user's authority to operate the equipment.

This device complies with Part 15 of the FCC Rules. Operation is subject to the following two conditions:

- (1) This device may not cause harmful interference
- (2) This device must accept any interference received, including interference that may cause undesired operation.

## Federal Communication Commission (FCC) Radiation Exposure Statement

This equipment complies with FCC radiation exposure set forth for an uncontrolled environment. In order to avoid the possibility of exceeding the FCC radio frequency exposure limits, human proximity to the antenna shall not be less than 20 cm (8 inches) during normal operation.

## R&TTE Compliance Statement

This equipment complies with all the requirements of DIRECTIVE 1999/5/CE OF THE EUROPEAN PARLIAMENT AND THE COUNCIL OF 9 March 1999 on radio equipment and telecommunication terminal Equipment and the mutual recognition of their conformity (R&TTE). The R&TTE Directive repeals and replaces in the directive 98/13/EEC (Telecommunications Terminal Equipment and Satellite Earth Station Equipment) as of April 8, 2000.

## Safety

This equipment is designed with the utmost care for the safety of those who install and use it. However, special attention must be paid to the dangers of electric shock and static electricity when working with electrical equipment. All guidelines of this and of the computer manufacture must therefore be allowed at all times to ensure the safe use of the equipment.

## National Restrictions

This device is intended for home and office use in all EU countries (and other countries following the EU directive 1999/5/EC) without any limitation except for the countries mentioned below:

Country	Restriction	Reasons/remarks
Bulgaria	None	General authorization required for outdoor use and public service
France	Outdoor use; limited to 10 mW e.i.r.p. within the band 2454-2483.5 MHz	Military Radiolocation use. Refarming of the 2.4 GHz band has been ongoing in recent years to allow current relaxed regulation. Full implementation planned 2012
Italy	None	If used outside of own premises, general authorization is required
Luxembourg	None	General authorization required for network and service supply(not for spectrum)
Norway	Implemented	This subsection does not apply for the geographical area within a radius of 20 km from the centre of Ny-Ålesund
Russian Federation	None	Only for indoor applications

**Note: Please don't use the product outdoors in France.**

## WEEE regulation



To avoid the potential effects on the environment and human health as a result of the presence of hazardous substances in electrical and electronic equipment, end users of electrical and electronic equipment should understand the meaning of the crossed-out wheeled bin symbol. Do not dispose of WEEE as unsorted municipal waste and have to collect such WEEE separately.

## **Revision**

User Manual of PLANET 1200Mbps 11ac Dual Band Ceiling-mount Wireless Access Point

Model: WDAP-C7200AC / WDAP-W7200AC

Rev: 1.1 (September, 2015)

Part No. EM-WDAP-C7200AC\_W7200AC\_v1.1 (2080-E11010-001)

# CONTENTS

<b>Chapter 1.Product Introduction</b> .....	<b>1</b>
<b>1.1 Package Contents</b> .....	<b>1</b>
<b>1.2 Product Description</b> .....	<b>2</b>
<b>1.3 Product Features</b> .....	<b>5</b>
<b>1.4 Product Specifications</b> .....	<b>6</b>
<b>Chapter 2.Hardware Installation</b> .....	<b>9</b>
<b>2.1 Product Outlook</b> .....	<b>9</b>
2.1.1 Panel Layout.....	11
2.1.2 Hardware Description.....	12
<b>Chapter 3.Connecting to the AP</b> .....	<b>13</b>
<b>3.1 System Requirements</b> .....	<b>13</b>
<b>3.2 Installing the AP</b> .....	<b>13</b>
3.2.1 Installing the AP – WDAP-C7200AC.....	13
3.2.2 Installing the AP – WDAP-W7200AC.....	16
<b>Chapter 4.Quick Installation Guide</b> .....	<b>20</b>
<b>4.1 Manual Network Setup - TCP/IP Configuration</b> .....	<b>20</b>
4.1.1 Configuring the IP Address Manually.....	20
<b>4.2 Starting Setup in the Web UI</b> .....	<b>24</b>
<b>Chapter 5.Configuring the AP</b> .....	<b>25</b>
<b>5.1 Operation Mode</b> .....	<b>25</b>
<b>5.2 Setup Wizard</b> .....	<b>27</b>
<b>5.3 TCP / IP Settings</b> .....	<b>34</b>
5.3.1 LAN Settings.....	34
<b>5.4 WLAN1 (5GHz)</b> .....	<b>36</b>
5.4.1 Basic Settings.....	36
5.4.2 Advanced Settings.....	52
5.4.3 RF Output Power.....	54
5.4.4 Security.....	55
5.4.5 Access Control.....	56
5.4.6 WDS.....	58
5.4.7 Site Survey.....	61
5.4.8 WPS.....	61
5.4.9 Schedule.....	65
<b>5.5 WLAN2 (2.4GHz)</b> .....	<b>66</b>
5.5.1 Basic Settings.....	66
5.5.2 Advanced Settings.....	82

5.5.3	RF Output Power .....	84
5.5.4	Security .....	85
5.5.5	Access Control.....	87
5.5.6	WDS.....	89
5.5.7	Site Survey .....	92
5.5.8	WPS.....	92
5.5.9	Schedule.....	96
<b>5.6</b>	<b>Management .....</b>	<b>97</b>
5.6.1	Status .....	97
5.6.2	Statistics.....	99
5.6.3	SNMP.....	100
5.6.4	NTP Settings.....	101
5.6.5	Scheduling Reboot .....	102
5.6.6	Log .....	105
5.6.7	Upgrading Firmware .....	106
5.6.8	Reload Settings .....	106
5.6.9	Password .....	108
5.6.10	LED Control .....	109
5.6.11	Logout.....	109
5.6.12	Reboot .....	110
<b>Chapter 6</b>	<b>Quick Connection to a Wireless Network .....</b>	<b>111</b>
6.1	Windows XP (Wireless Zero Configuration).....	111
6.2	Windows 7 (WLAN AutoConfig).....	113
6.3	Mac OS X 10.x.....	116
6.4	iPhone / iPod Touch / iPad .....	120
<b>Appendix A:</b>	<b>Planet Smart Discovery Utility.....</b>	<b>123</b>
<b>Appendix B:</b>	<b>FAQs.....</b>	<b>124</b>
Q1:	How to set up the WDS Repeater Connection.....	124
Q2:	How to set up the Universal Repeater Connection.....	133
<b>Appendix B:</b>	<b>Troubleshooting.....</b>	<b>140</b>
<b>Appendix C:</b>	<b>Glossary.....</b>	<b>142</b>

# FIGURE

<b>FIGURE 2-1</b> WDAP-C7200AC PRODUCT DRAWING.....	9
<b>FIGURE 2-2</b> WDAP-W7200AC PRODUCT DRAWING.....	10
<b>FIGURE 2-3</b> WDAP-C7200AC PANEL LAYOUT .....	11
<b>FIGURE 2-4</b> WDAP-W7200AC PANEL LAYOUT .....	11
<b>FIGURE 3-1</b> WDAP-C7200AC INSTALLATION DIAGRAM 1 .....	13
<b>FIGURE 3-2</b> WDAP-C7200AC INSTALLATION DIAGRAM 2 .....	14
<b>FIGURE 3-3</b> WDAP-C7200AC INSTALLATION DIAGRAM 3 .....	14
<b>FIGURE 3-4</b> WDAP-C7200AC INSTALLATION DIAGRAM 4 .....	15
<b>FIGURE 3-5</b> WDAP-C7200AC INSTALLATION DIAGRAM 4 .....	15
<b>FIGURE 3-6</b> WDAP-W7200AC INSTALLATION DIAGRAM 1 .....	16
<b>FIGURE 3-7</b> WDAP-W7200AC INSTALLATION DIAGRAM 2 .....	16
<b>FIGURE 3-8</b> WDAP-W7200AC INSTALLATION DIAGRAM 3 .....	17
<b>FIGURE 3-9</b> WDAP-W7200AC INSTALLATION DIAGRAM 4 .....	17
<b>FIGURE 3-10</b> WDAP-W7200AC INSTALLATION DIAGRAM 5 .....	18
<b>FIGURE 3-11</b> WDAP-W7200AC INSTALLATION DIAGRAM 6 .....	18
<b>FIGURE 3-12</b> WDAP-W7200AC INSTALLATION DIAGRAM 7 .....	19
<b>FIGURE 4-1</b> TCP/IP SETTING .....	21
<b>FIGURE 4-2</b> WINDOWS START MENU .....	22
<b>FIGURE 4-3</b> SUCCESSFUL RESULT OF PING COMMAND .....	22
<b>FIGURE 4-4</b> FAILED RESULT OF PING COMMAND .....	23
<b>FIGURE 4-5</b> LOGIN BY DEFAULT IP ADDRESS .....	24
<b>FIGURE 4-6</b> LOGIN WINDOW .....	24
<b>FIGURE 5-1</b> MAIN MENU .....	25
<b>FIGURE 5-2</b> OPERATION MODE .....	26
<b>FIGURE 5-3</b> SETUP WIZARD .....	27
<b>FIGURE 5-4</b> LAN INTERFACE SETUP TOPOLOGY .....	27
<b>FIGURE 5-5</b> WIZARD – LAN INTERFACE SETUP .....	27
<b>FIGURE 5-6</b> TIME ZONE SETUP TOPOLOGY .....	28
<b>FIGURE 5-7</b> WIZARD – TIME ZONE SETUP .....	28
<b>FIGURE 5-8</b> WIZARD – WIRELESS 5GHZ BASIC SETTINGS.....	29
<b>FIGURE 5-9</b> WIZARD – WIRELESS 5GHZ SECURITY SETUP .....	29
<b>FIGURE 5-10</b> 5GHZ WIRELESS SECURITY SETUP – WEP SETTING .....	30
<b>FIGURE 5-11</b> 5GHZ WIRELESS SECURITY SETUP – WPA SETTING .....	30
<b>FIGURE 5-12</b> WIZARD – WIRELESS 2.4GHZ BASIC SETTINGS.....	31
<b>FIGURE 5-13</b> WIZARD – WIRELESS 2.4GHZ SECURITY SETUP .....	31
<b>FIGURE 5-14</b> 2.4GHZ WIRELESS SECURITY SETUP – WEP SETTING .....	32
<b>FIGURE 5-15</b> 2.4GHZ WIRELESS SECURITY SETUP – WPA SETTING .....	32
<b>FIGURE 5-16</b> SETUP WIZARD - FINISHED .....	33
<b>FIGURE 5-17</b> LAN SETTING.....	34
<b>FIGURE 5-18</b> 5GHZ WIRELESS MAIN MENU .....	36
<b>FIGURE 5-19</b> 5GHZ WIRELESS BASIC SETTINGS OF AP .....	37
<b>FIGURE 5-20</b> 5GHZ WIRELESS BASIC SETTINGS – MULTIPLE AP .....	39

<b>FIGURE 5-21 5GHZ MULTIPLE-SSID</b> .....	40
<b>FIGURE 5-22 5GHZ UNIVERSAL REPEATER-1</b> .....	41
<b>FIGURE 5-23 5GHZ UNIVERSAL REPEATER-2</b> .....	41
<b>FIGURE 5-24 5GHZ UNIVERSAL REPEATER-3</b> .....	42
<b>FIGURE 5-25 5GHZ UNIVERSAL REPEATER-4</b> .....	42
<b>FIGURE 5-26 5GHZ UNIVERSAL REPEATER-5</b> .....	42
<b>FIGURE 5-27 5GHZ WIRELESS BASIC SETTINGS – CLIENT</b> .....	43
<b>FIGURE 5-28 CLIENT – SURVEY</b> .....	45
<b>FIGURE 5-29 CLIENT – AP LIST</b> .....	46
<b>FIGURE 5-30 CLIENT – SECURITY</b> .....	46
<b>FIGURE 5-31 CLIENT – STATUS</b> .....	47
<b>FIGURE 5-32 5GHZ WIRELESS BASIC SETTINGS – WDS</b> .....	48
<b>FIGURE 5-33 5GHZ WIRELESS BASIC SETTINGS – WDS+AP</b> .....	50
<b>FIGURE 5-34 WIRELESS ADVANCED SETTINGS – 5GHZ</b> .....	52
<b>FIGURE 5-35 RF OUTPUT POWER – 5GHZ</b> .....	54
<b>FIGURE 5-36 WIRELESS SECURITY SETTINGS – 5GHZ</b> .....	55
<b>FIGURE 5-37 WIRELESS ACCESS CONTROL – 5GHZ</b> .....	56
<b>FIGURE 5-38 WIRELESS ACCESS CONTROL – DENY</b> .....	57
<b>FIGURE 5-39 WDS MODE – 5GHZ</b> .....	59
<b>FIGURE 5-40 WDS SETTINGS – 5GHZ</b> .....	59
<b>FIGURE 5-41 WDS – SET SECURITY</b> .....	60
<b>FIGURE 5-42 SITE SURVEY – 5GHZ</b> .....	61
<b>FIGURE 5-43 WPS-PBC – 5GHZ-1</b> .....	63
<b>FIGURE 5-44 WPS-PBC – 5GHZ-2</b> .....	63
<b>FIGURE 5-45 WPS-PIN – 5GHZ-1</b> .....	64
<b>FIGURE 5-46 WPS-PIN – 5GHZ-2</b> .....	64
<b>FIGURE 5-47 WPS-PIN – 5GHZ-3</b> .....	64
<b>FIGURE 5-48 SCHEDULE - 5GHZ</b> .....	65
<b>FIGURE 5-49 2.4GHZ WIRELESS MAIN MENU</b> .....	66
<b>FIGURE 5-50 2.4GHZ WIRELESS BASIC SETTINGS – AP</b> .....	67
<b>FIGURE 5-51 2.4GHZ WIRELESS BASIC SETTINGS – MULTIPLE AP</b> .....	69
<b>FIGURE 5-52 2.4GHZ MULTIPLE-SSID</b> .....	70
<b>FIGURE 5-53 2.4GHZ UNIVERSAL REPEATER-1</b> .....	71
<b>FIGURE 5-54 2.4GHZ UNIVERSAL REPEATER-2</b> .....	71
<b>FIGURE 5-55 2.4GHZ UNIVERSAL REPEATER-3</b> .....	72
<b>FIGURE 5-56 2.4GHZ UNIVERSAL REPEATER-4</b> .....	72
<b>FIGURE 5-57 2.4GHZ UNIVERSAL REPEATER-5</b> .....	72
<b>FIGURE 5-58 2.4GHZ WIRELESS BASIC SETTINGS – CLIENT</b> .....	73
<b>FIGURE 5-59 CLIENT – SURVEY</b> .....	75
<b>FIGURE 5-60 CLIENT – AP LIST</b> .....	76
<b>FIGURE 5-61 CLIENT – SECURITY</b> .....	77
<b>FIGURE 5-62 CLIENT – STATUS</b> .....	77
<b>FIGURE 5-63 2.4GHZ WIRELESS BASIC SETTINGS – WDS</b> .....	78
<b>FIGURE 5-64 2.4GHZ WIRELESS BASIC SETTINGS – WDS+AP</b> .....	80
<b>FIGURE 5-65 WIRELESS ADVANCED SETTINGS – 2.4GHZ</b> .....	82




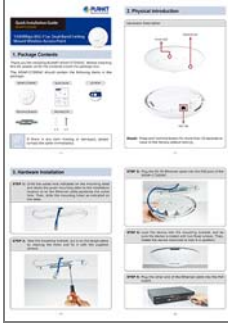


<b>FIGURE 5-66</b> RF OUTPUT POWER – 2.4GHZ .....	84
<b>FIGURE 5-67</b> WIRELESS SECURITY SETTINGS – 2.4GHZ .....	85
<b>FIGURE 5-68</b> WIRELESS ACCESS CONTROL – 2.4GHZ .....	87
<b>FIGURE 5-69</b> WIRELESS ACCESS CONTROL – DENY .....	88
<b>FIGURE 5-70</b> WDS MODE – 2.4GHZ .....	90
<b>FIGURE 5-71</b> WDS SETTINGS – 2.4GHZ .....	90
<b>FIGURE 5-72</b> WDS – SET SECURITY .....	91
<b>FIGURE 5-73</b> SITE SURVEY – 2.4GHZ .....	92
<b>FIGURE 5-74</b> WPS-PBC – 2.4GHZ-1 .....	94
<b>FIGURE 5-75</b> WPS-PBC – 2.4GHZ-2 .....	94
<b>FIGURE 5-76</b> WPS-PIN – 2.4GHZ-1 .....	95
<b>FIGURE 5-77</b> WPS-PIN – 2.4GHZ-2 .....	95
<b>FIGURE 5-78</b> WPS-PIN – 2.4GHZ-3 .....	95
<b>FIGURE 5-79</b> SCHEDULE – 2.4GHZ .....	96
<b>FIGURE 5-80</b> MANAGEMENT – MAIN MENU .....	97
<b>FIGURE 5-81</b> STATUS .....	98
<b>FIGURE 5-82</b> STATISTICS .....	99
<b>FIGURE 5-83</b> SNMP .....	100
<b>FIGURE 5-84</b> TIME ZONE SETTINGS .....	101
<b>FIGURE 5-85</b> SCHEDULING REBOOT .....	102
<b>FIGURE 5-86</b> SCHEDULING REBOOT - EXAMPLE .....	104
<b>FIGURE 5-87</b> SYSTEM LOG .....	105
<b>FIGURE 5-88</b> UPGRADING FIRMWARE .....	106
<b>FIGURE 5-89</b> SAVE/RELOAD SETTINGS .....	107
<b>FIGURE 5-90</b> PASSWORD SETUP .....	108
<b>FIGURE 5-91</b> LED CONTROL .....	109
<b>FIGURE 5-92</b> LOGOUT .....	109
<b>FIGURE 5-93</b> REBOOT .....	110
<b>FIGURE 6-1</b> SYSTEM TRAY – WIRELESS NETWORK ICON .....	111
<b>FIGURE 6-2</b> CHOOSING A WIRELESS NETWORK .....	111
<b>FIGURE 6-3</b> ENTERING THE NETWORK KEY .....	112
<b>FIGURE 6-4</b> CHOOSING A WIRELESS NETWORK -- CONNECTED .....	112
<b>FIGURE 6-5</b> NETWORK ICON .....	113
<b>FIGURE 6-6</b> WLAN AUTOCONFIG .....	113
<b>FIGURE 6-7</b> TYPING THE NETWORK KEY .....	114
<b>FIGURE 6-8</b> CONNECTING TO A NETWORK .....	114
<b>FIGURE 6-9</b> CONNECTED TO A NETWORK .....	115
<b>FIGURE 6-10</b> MAC OS – NETWORK ICON .....	116
<b>FIGURE 6-11</b> HIGHLIGHTING AND SELECTING THE WIRELESS NETWORK .....	116
<b>FIGURE 6-12</b> ENTERING THE PASSWORD .....	117
<b>FIGURE 6-13</b> CONNECTED TO THE NETWORK .....	117
<b>FIGURE 6-14</b> SYSTEM PREFERENCES .....	118
<b>FIGURE 6-15</b> SYSTEM PREFERENCES -- NETWORK .....	118
<b>FIGURE 6-16</b> SELECTING THE WIRELESS NETWORK .....	119
<b>FIGURE 6-17</b> IPHONE – SETTINGS ICON .....	120

<b>FIGURE 6-18</b> WI-FI SETTING .....	120
<b>FIGURE 6-19</b> WI-FI SETTING – NOT CONNECTED .....	121
<b>FIGURE 6-20</b> TURNING ON WI-FI.....	121
<b>FIGURE 6-21</b> IPHONE -- ENTERING THE PASSWORD.....	122
<b>FIGURE 6-22</b> IPHONE -- CONNECTED TO THE NETWORK .....	122

# Chapter 1. Product Introduction

## 1.1 Package Contents

Thank you for choosing PLANET WDAP-C7200AC or WDAP-W7200AC. Before installing the AP, please verify the contents inside the package box.

Package Contents of WDAP-C7200AC			
<b>WDAP-C7200AC</b> 	<b>Quick Guide</b> 	<b>Mounting Bracket</b> 	<b>Mounting Kit</b>  <p style="text-align: right;">x3    x3</p>

Package Contents of WDAP-W7200AC			
<b>WDAP-W7200AC</b> 	<b>Quick Guide</b> 	<b>2.4G Antenna x 2</b> <b>5G Antenna x 2</b> 	<b>DIN-rail Kit</b> 
<b>Magnet Kit</b> 	<b>Wall-mounted Kit</b> 		



If there is any item missing or damaged, please contact the seller immediately.

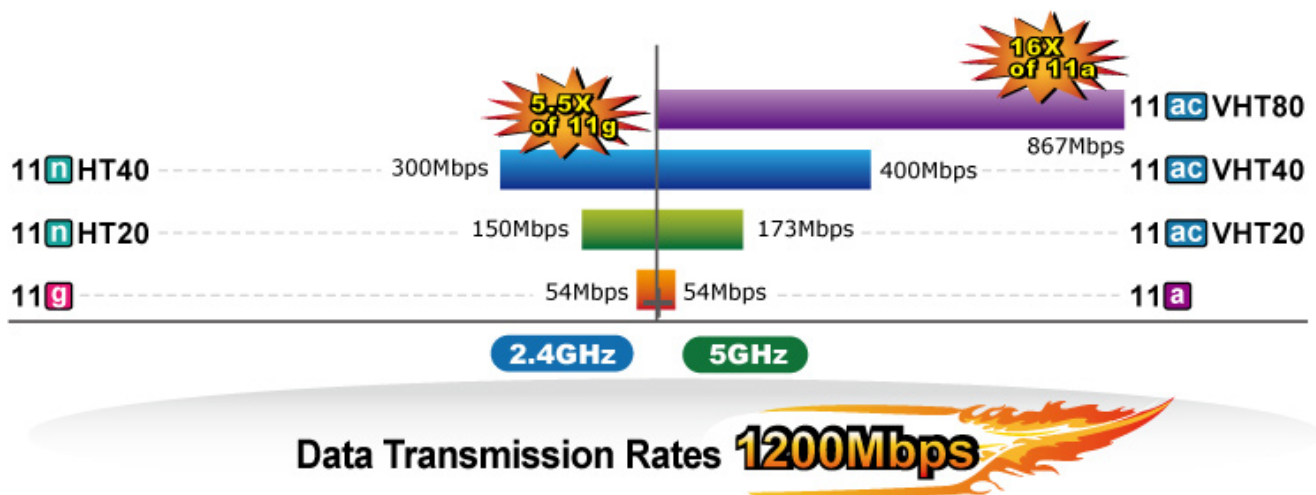
## 1.2 Product Description

### Designed for Highly-efficient Wireless Coverage

PLANET WDAP-C7200AC and WDAP-W7200AC, an IEEE 802.3at compliant PoE access point, features the latest 802.11ac wireless technology, advanced management functions and superior encryption standard yet cost-effectiveness. Meeting today's demand for advanced performance and security, the WDAP-C7200AC and WDAP-W7200AC include multiple SSIDs, WPA / WPA2, RADIUS MAC authentication and so forth.

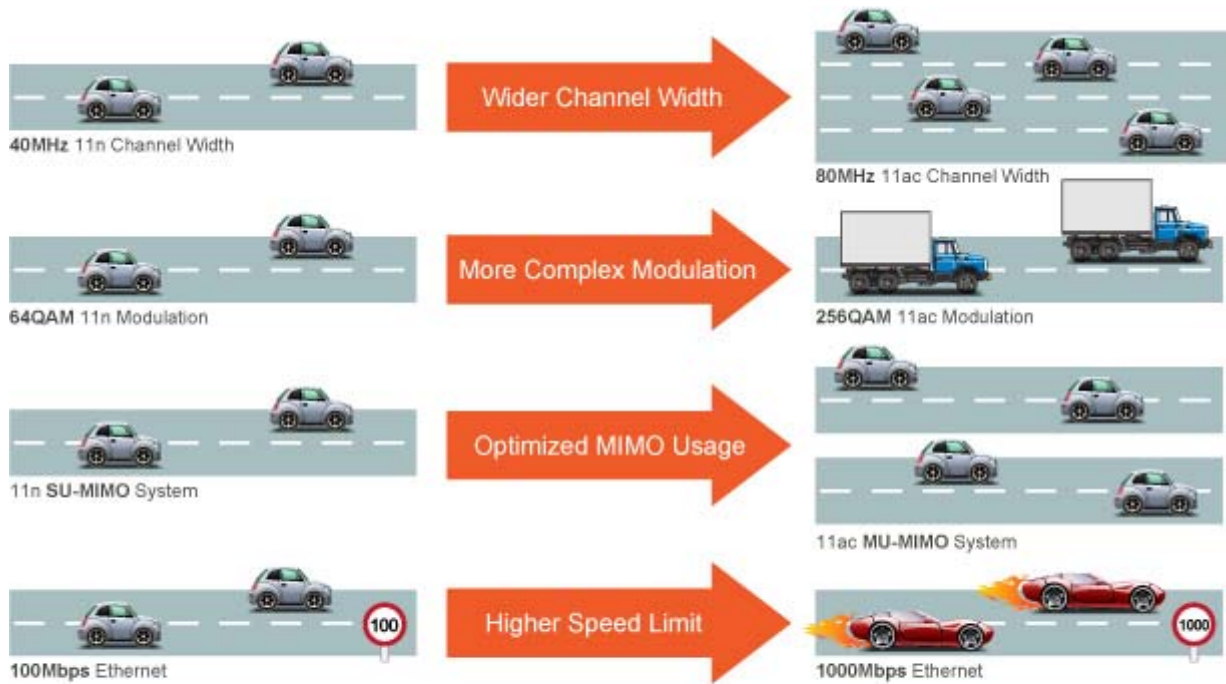
### Brand-new 11ac Wireless Technology

The WDAP-C7200AC and WDAP-W7200AC support IEEE 802.11a/b/g/n/ac dual band standards with 2T2R MIMO technology; therefore, it provides the wireless speed up to 300+867Mbps, which is 16X faster than the 11a access point at 5GHz frequency and 5.5X faster than the 11g access point at 2.4GHz frequency. Moreover, the WDAP-C7200AC and WDAP-W7200AC are equipped with Gigabit Ethernet Port. Compared with the general wireless APs, the WDAP-C7200AC and WDAP-W7200AC offer faster transmission speed for the network applications and less interference to enhance data throughput. The incredible wireless speed makes it ideal for handling multiple HD movie streams, high-resolution on-line games, stereo music, VoIPs and data streams at the same time stably and smoothly.



### 11ac Innovations Bring Excellent Data Link Speed

The WDAP-C7200AC and WDAP-W7200AC are built-in with high power amplifier and 4 highly-sensitive antennas which provide stronger signal and excellent coverage even in the wide-ranging or bad environment. With adjustable transmit power option, the administrator can flexibly reduce or increase the output power for various environments, thus reducing interference to achieve maximum performance. To provide extremely high-speed user experience, the WDAP-C7200AC and WDAP-W7200AC adopted IEEE 802.11ac technology to extend the 802.11n 40MHz channel binding to 80MHz and the implementation of 256-QAM modulation where higher transmitting/receiving rates go up to 867Mbps in 5GHz less interference frequency band. In addition, the Gigabit LAN port can eliminate the restriction of 100Mbps Fast Ethernet wired connection to let users fully enjoy the high speed provided by wireless. The IEEE 802.11ac also optimizes MU-MIMO (Multi-User MIMO) mechanism to serve multiple devices simultaneously.



## Go faster in wired & wireless

Take Advantage of 11ac to Optimize Data Link Speed

### Full Support of Wireless Security Encryption and Wireless Value-added Features

In aspect of security, besides 64/128-bit WEP encryption, the WDAP-C7200AC and WDAP-W7200AC are integrated with WPA / WPA2, WPA-PSK / WPA2-PSK and 802.1x RADIUS authority to secure and protect your wireless LAN. It provides the wireless MAC filtering and SSID broadcast control to consolidate the wireless network security and prevent unauthorized wireless connection. Moreover, its Wi-Fi Multimedia (WMM) mechanism provides enhanced QoS over wireless connection for better performance in multimedia transmission like on-line gaming and video streaming, which are classified as a top priority.

### Multiple Operation Modes for Various Applications

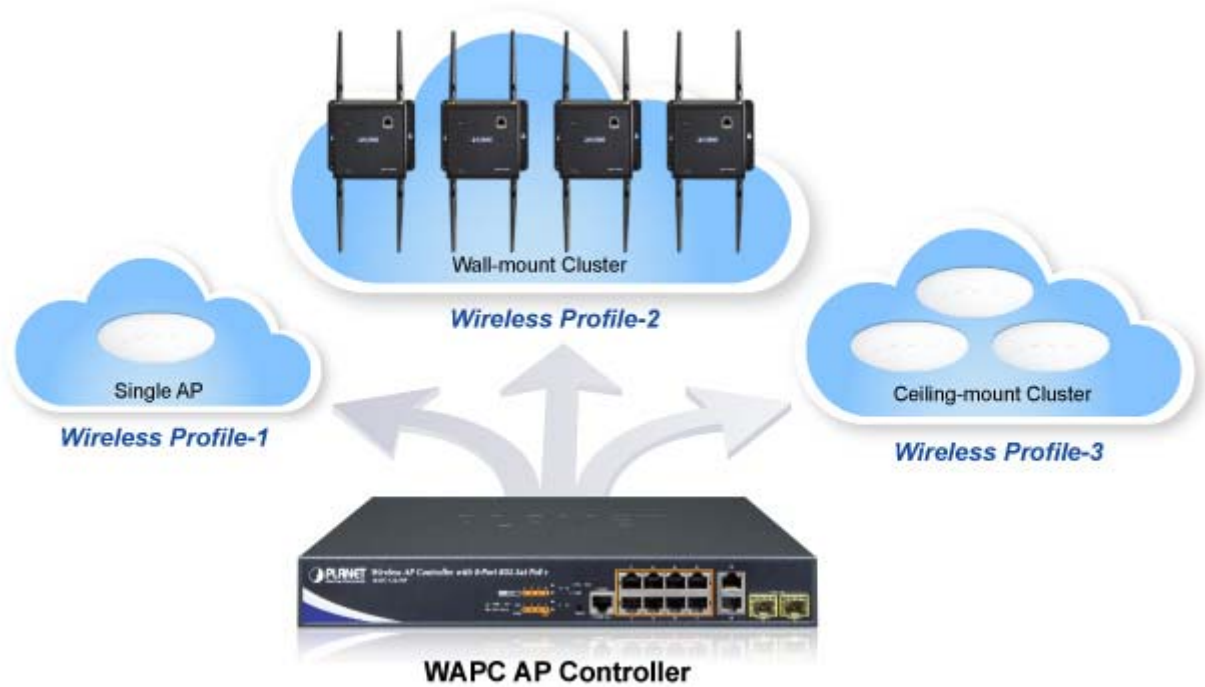
The WDAP-C7200AC and WDAP-W7200AC support AP, Client, WDS Bridge, Repeater and Universal Repeater modes, through which it provides more flexibility for users when wireless network is established. Compared with general wireless access point, the WDAP-C7200AC and WDAP-W7200AC offer more powerful and flexible capability for wireless clients.

### Flexible Deployment with PoE Feature

Compliant with the IEEE 802.3at Power over Ethernet standard, the WDAP-C7200AC and WDAP-W7200AC can be powered and networked by a single UTP cable. It thus reduces the needs of extra cables and dedicated electrical outlets on the wall, ceiling or any other place where it is difficult to reach. The wireless network deployment becomes more flexible and worry-free from the power outlet locations.

### Deployment Simplified through Centralized Management

The WDAP-C7200AC and WDAP-W7200AC support AP controller which can be switched to “managed AP” mode and thus can be centrally managed by PLANET WAPC-1232HP smart AP controller. It will certainly benefit the system integrators when the scale of the wireless network gets bigger. Furthermore, with user-friendly Web UI and Planet Smart Discovery supported, the WDAP-C7200AC and WDAP-W7200AC are convenient to be managed and configured remotely in a small business wireless network.



## 1.3 Product Features

- **Standard Compliant Hardware Interface**
  - Complies with IEEE 802.11ac (draft 2.0) and IEEE 802.11a/b/g/n standards
  - 1 10/100/1000BASE-TX port with 1-port PoE powered device (PD)
  - IEEE 802.3at Power over Ethernet design
  
- **RF Interface Characteristics**
  - Features 2.4GHz (802.11b/g/n) and 5GHz (802.11a/n/ac) concurrent dual band for more efficiency of carrying high load traffic
  - 4 built-in, high-gain antennas provide excellent wireless coverage
  - Flexible RP-SMA connectors easily expand the existing wireless network (WDAP-W7200AC)
  - 2T2R MIMO technology for enhanced throughput and coverage
  - Provides multiply-adjustable transmit power control
  - High speed up to 1.2Gbps (300Mbps for 2.4GHz + 867Mbps for 5GHz) wireless data rate
  
- **Comprehensive Wireless Advanced Features**
  - Multiple Wireless Modes: AP, Client, WDS PtP/ PtMP, WDS Repeater, Universal Repeater
  - Supports up to 10 multiple-SSIDs (2.4GHz + 5GHz) to allow users to access different networks through a single AP
  - Supports WMM (Wi-Fi Multimedia) and wireless QoS to enhance the efficiency of multimedia application
  - Supports IAPP (Inter Access Point Protocol) and wireless roaming to enable clients to roam across different wireless networks
  - Supports 5-level Transmitting Power Control to adapt various environments
  - Supports wireless schedule to automatically enable or disable the wireless function based on predefined schedule
  - Self-healing (Schedule Reboot) mechanism for reliable connection
  
- **Secure Network Connection**
  - Advanced Security: 64/128-bit WEP, WPA / WPA2, WPA-PSK / WPA2-PSK (TKIP/AES encryption) and 802.1x Radius Authentication
  - Supports MAC address filtering
  
- **Easy Installation & Management**
  - Flexible deployment with standard 802.3at PoE/PD supported
  - Web-based UI and Quick Setup Wizard for easy configuration
  - SNMP-based management interface
  - System status monitoring includes DHCP Client and System Log
  - Supports AP controller to enable administrator to configure and monitor multiple APs simultaneously



## 1.4 Product Specifications

<b>Model Name</b>	<b>WDAP-C7200AC</b>	<b>WDAP-W7200AC</b>
<b>Description</b>	WDAP-C7200AC: 1200Mbps 802.11ac Dual Band Ceiling-mount Wireless AP WDAP-W7200AC: 1200Mbps 802.11ac Dual Band Wall-mount Wireless AP	
<b>Hardware Features</b>		
<b>Interfaces</b>	LAN: 1 x 10/100/1000BASE-T RJ45 port; auto-negotiation and auto MDI/MDI-X	
<b>Antennas</b>	2 x 2.4GHz 2.5dBi PCB antenna 2 x 5GHz 4dBi PCB antenna	2 x 2.4GHz 5dBi SMA antenna 2 x 5GHz 5dBi SMA antenna
<b>Reset Button</b>	Reset button on the top cover Press over 5 seconds to reset the device to factory default	
<b>LED Indicators</b>	PWR Allow LED to turn off via software control	
<b>Material</b>	Plastic	IP30 rated, metal
<b>Dimensions</b>	194 x 49 mm (Φ x H)	148 x 41 x 140 mm (W x D x H)
<b>Weight</b>	300 ±5g	470 ±5g
<b>Power Requirements</b>	802.3at PoE, 48-56V DC input	
<b>Power Consumption</b>	20W (max.)	20W (max.)
<b>Mounting</b>	Ceiling Mount	Wall Mount
<b>Wireless Interface Specifications</b>		
<b>Standard</b>	IEEE 802.11ac (Draft 2.0) 5GHz IEEE 802.11a/n 5GHz IEEE 802.11b/g/n 2.4GHz	
<b>Antenna Structure</b>	802.11ac: 2T2R MU-MIMO 802.11n: 2T2R MIMO	
<b>Modulation</b>	DSSS	
<b>Data Modulation</b>	802.11ac: OFDM (BPSK / QPSK / 16QAM / 64QAM / 256QAM) 802.11a/g/n: OFDM (BPSK / QPSK / 16QAM / 64QAM) 802.11b: DSSS (DBPSK / DQPSK / CCK)	
<b>Band Mode</b>	2.4G / 5G concurrent mode	
<b>Frequency Range</b>	<b>2.4GHz:</b> America -- FCC: 2.412~2.462GHz Europe -- ETSI: 2.412~2.484GHz  <b>5GHz:</b> America -- FCC: 5.180~5.240GHz, 5.725~5.850GHz Europe -- ETSI: 5.180~5.240GHz	
<b>Operating Channels</b>	<b>2.4GHz:</b> America -- FCC: 1~11 Europe -- ETSI: 1~13  <b>5GHz:</b> America -- FCC: 36, 40, 44, 48, 149, 153, 157, 161, 165 Europe -- ETSI: 36, 40, 44, 48 5GHz channel list will vary in different countries according to their regulations.	
<b>Channel Width</b>	802.11ac: 20/40/80MHz	



	802.11n: 20/40MHz
<b>Data Transmission Rates</b>	802.11ac (VHT20, Nss2-MCS8): Up to 173.3Mbps 802.11ac (VHT40, Nss2-MCS9): Up to 400Mbps 802.11ac (VHT80, Nss2-MCS9): Up to 867Mbps
	802.11n (HT40): 270/243/216/162/108/81/54/27Mbps 135/121.5/108/81/54/40.5/27/13.5Mbps (dynamic)
	802.11n (HT20): 130/117/104/78/52/39/26/13Mbps 65/58.5/52/39/26/19.5/13/6.5Mbps (dynamic)
	802.11g: 54/48/36/24/18/12/9/6Mbps (dynamic)
	802.11b: 11/5.5/2/1Mbps (dynamic)
<b>Transmission Distance</b>	802.11ac (draft): up to 30m 802.11n: up to 70m 802.11g: up to 30m  <b>The estimated transmission distance is based on the theory. The actual distance will vary in different environments.</b>
<b>Max. RF Power</b>	<b>5GHz:</b> 802.11ac (VHT20): 22dBm 802.11ac (VHT40): 22dBm 802.11ac (VHT80): 22dBm 802.11n (HT20): 22dBm 802.11n (HT40): 22dBm 802.11a: 22dBm
	<b>2.4GHz:</b> 802.11n: 17 ±2.5dBm 802.11b/g: 20 ±2.5dBm
<b>Receive Sensitivity</b>	<b>5GHz:</b> 802.11ac (VHT20): -91dBm @ Nss1-MCS0, -64dBm @ Nss2-MCS8 802.11ac (VHT40): -89dBm @ Nss1-MCS0, -59dBm @ Nss2-MCS9 802.11ac (VHT80): -86dBm @ Nss1-MCS0, -56dBm @ Nss2-MCS9 802.11n (HT20): -92dBm @ MCS0, -71dBm @ MCS7 802.11n (HT40): -89dBm @ MCS0, -66dBm @ MCS15 802.11a: -93 @ 6Mbps, -75dBm @ 54Mbps
	<b>2.4GHz:</b> 802.11n 20MHz (MCS7): -69dBm @10% PER 802.11n 40MHz (MCS15): -66dBm @10% PER 802.11g (54Mbps): -74dBm @10% PER 802.11b (11Mbps): -88dBm @10% PER
<b>Software Features</b>	
<b>Operation Mode</b>	<ul style="list-style-type: none"> <li>■ Standalone AP</li> <li>■ Managed AP</li> </ul>
<b>Wireless Mode</b>	<ul style="list-style-type: none"> <li>■ Universal Repeater (AP+Client)</li> <li>■ Repeater (WDS+AP)</li> <li>■ AP (Access Point)</li> <li>■ WDS PTP (Point to Point)</li> <li>■ WDS PTMP (Point to Multipoint)</li> <li>■ Client</li> </ul>

<b>Encryption Security</b>	<ul style="list-style-type: none"> <li>■ WEP (64/128-bit) encryption security</li> <li>■ WPA / WPA2 (TKIP/AES)</li> <li>■ WPA-PSK / WPA2-PSK (TKIP/AES)</li> <li>■ 802.1x RADIUS Authentication</li> </ul>	
<b>Wireless Security</b>	Provides wireless LAN ACL (Access Control List) filtering	
	Wireless MAC address filtering	
	Supports WPS (Wi-Fi Protected Setup)	
	Enable/Disable SSID broadcast	
<b>Wireless Advanced</b>	WMM (Wi-Fi Multimedia): 802.11e Wireless QoS	
	Multiple SSID: up to 5 at 2.4GHz and 5GHz, respectively	
	Wireless Isolation: Enables to isolate each connected wireless client from communicating with each other	
	IAPP (Inter Access Point Protocol): 802.11f Wireless Roaming	
	Provides wireless statistics	
<b>Max. Clients</b>	Wire: 253 2.4GHz wireless: 32 5GHz wireless: 32	
<b>LAN</b>	Built-in DHCP server supporting static IP address distribution	
	Supports UPnP	
	Supports 802.1d Spanning Tree	
<b>System Management</b>	Web-based (HTTP) management interface	
	SNTP time synchronize	
	Easy firmware upgrade	
	Supports Scheduling Reboot	
	Supports Smart Discovery Utility	
	Supports AP Controller	
<b>Standards Conformance</b>		
<b>IEEE Standards</b>	IEEE 802.11ac (Draft 2.0, 2T2R, up to 867Mbps) IEEE 802.11n (2T2R, up to 300Mbps) IEEE 802.11g IEEE 802.11b IEEE 802.11i IEEE 802.3 10BASE-T IEEE 802.3u 100BASE-TX IEEE 802.3ab 1000BASE-T IEEE 802.3x flow control	
<b>Other Protocols and Standards</b>	CSMA/CA, CSMA/CD, TCP/IP, DHCP, ICMP, SNTP	
<b>Environment &amp; Certification</b>		
<b>Temperature</b>	Operating: 0 ~ 50 degrees C	Operating: -10 ~ 60 degrees C
	Storage: -40 ~ 70 degrees C	Storage: -20 ~ 60 degrees C
<b>Humidity</b>	Operating: 10 ~ 90% (non-condensing) Storage: 5 ~ 90% (non-condensing)	
<b>Regulatory</b>	FCC Part 15B & 15C, IC, RoHS	

# Chapter 2. Hardware Installation

## 2.1 Product Outlook

### WDAP-C7200AC

- Dimensions: 194 x 49 mm (Φ x H)
- Drawing :

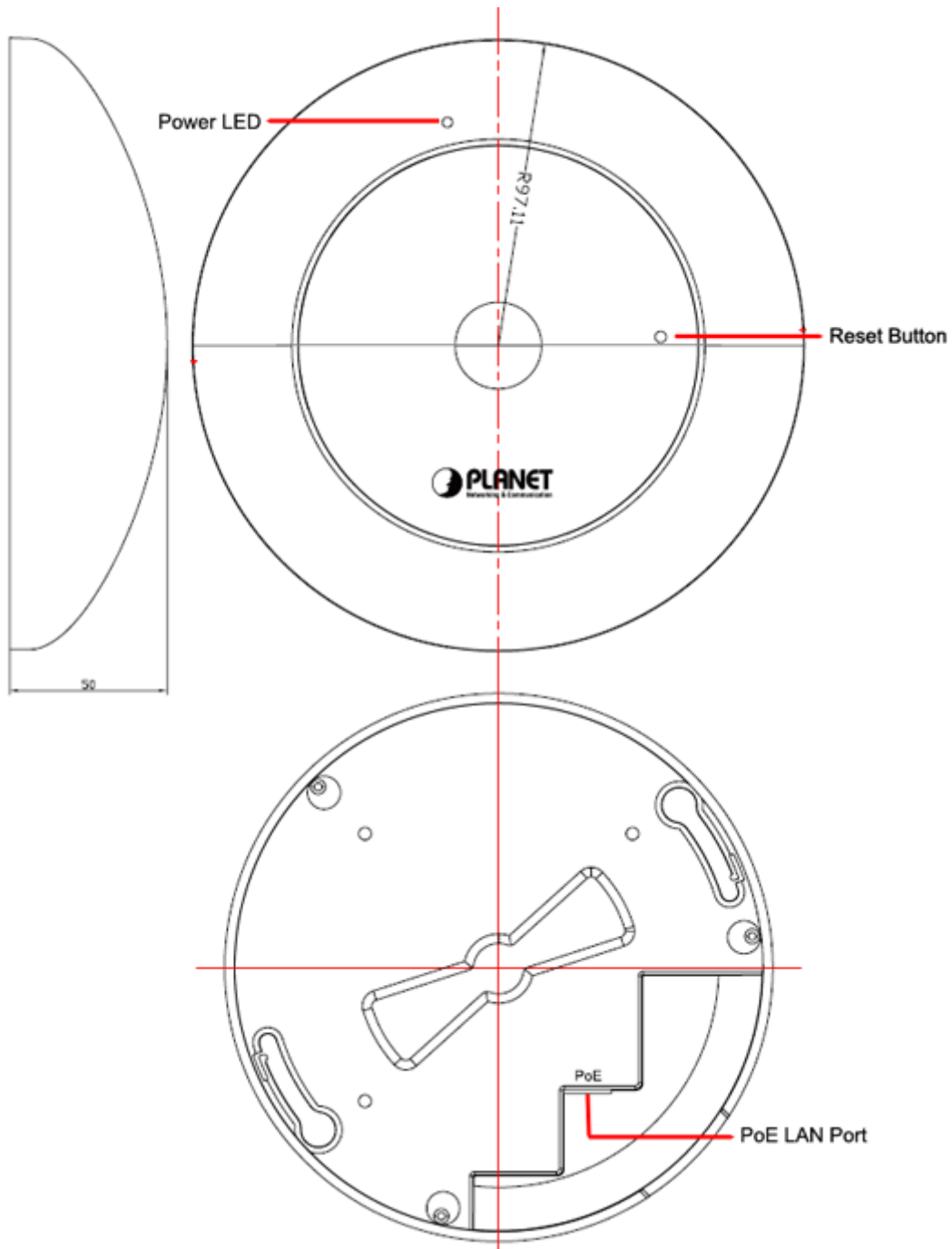
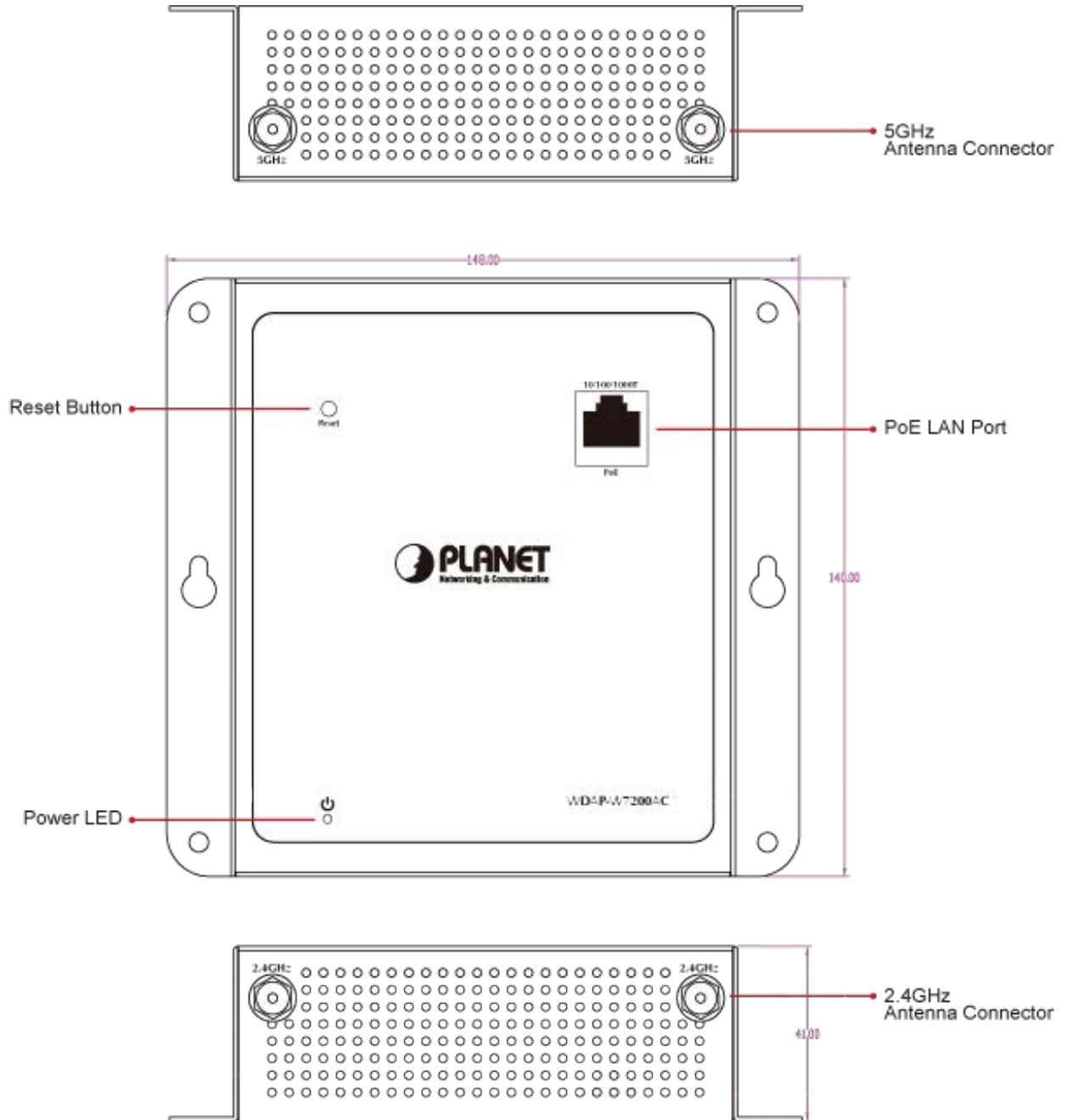


Figure 2-1 WDAP-C7200AC Product Drawing

**WDAP-W7200AC**

- **Dimensions:** 148 x 41 x 140 mm (W x D x H)
- **Drawing :**



**Figure 2-2** WDAP-W7200AC Product Drawing

### 2.1.1 Panel Layout

The front and rear panels provide a simple interface monitoring the AP. [Figure 2-2](#) shows the hardware interface of the WDAP-C7200AC.

#### WDAP-C7200AC Hardware Interface:



Figure 2-3 WDAP-C7200AC Panel Layout

#### WDAP-W7200AC Hardware Interface:

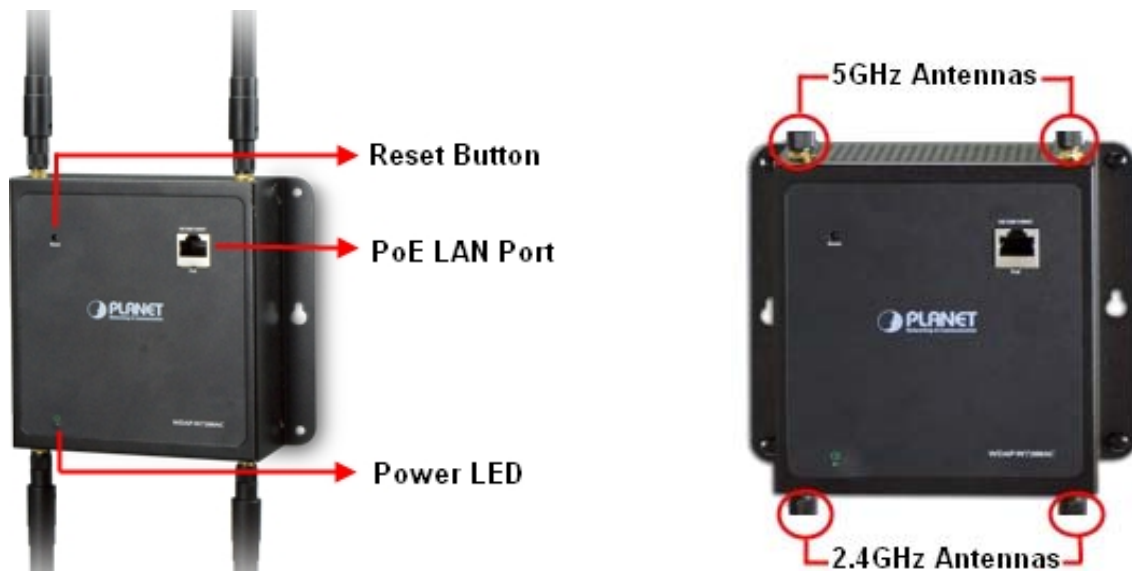


Figure 2-4 WDAP-W7200AC Panel Layout

## 2.1.2 Hardware Description

### LED Definition

LED	COLOR	STATUS	FUNCTION
PWR	Green	On	Device power on
	Green	Off	Device power off (controlled by S/W)
	Orange	On	System initializing; turn it off when system completed
	Orange	Blinking	Detect and identify the LED (controlled by S/W) 1) Position LED on: LED blinks continuously. 2) Position LED off: the LED is off.

### Button Definition

Object	Description
Reset	To restore to the factory default setting, press and hold the Reset Button over 5 seconds, and then release it.

### Port Definition

Object	Description
PoE Port (802.3at PoE)	10/100/1000Mbps RJ-45 port, auto MDI/ MDI-X Connect PoE port to the IEEE 802.3at PSE to power on the device.

## Chapter 3. Connecting to the AP

### 3.1 System Requirements

- Broadband Internet Access Service (Cable/xDSL/Ethernet connection)
- One IEEE 802.3at PoE switch (supply power to the WDAP-C7200AC)
- PCs with a working Ethernet adapter and an Ethernet cable with RJ45 connectors
- PCs running Windows 98/ME, NT4.0, 2000/XP, Windows Vista / Win 7, MAC OS 9 or later, Linux, UNIX or other platforms compatible with **TCP/IP** protocols



1. The AP in the following instructions refers to PLANET WDAP-C7200AC/ WDAP-W7200AC.
2. It is recommended to use Internet Explorer 7.0 or above to access the AP.

### 3.2 Installing the AP

Before installing the AP, make sure your PoE switch is connected to the Internet through the broadband service successfully at this moment. If there is any problem, please contact your local ISP. After that, please install the AP according to the following steps. Don't forget to pull out the power plug and keep your hands dry.

#### 3.2.1 Installing the AP – WDAP-C7200AC

**Step 1.** Drill the outlet hole indicated on the mounting label and stick the given mounting label to the installation location to let the Ethernet cable penetrate the outlet hole. Then, drill the mounting holes as indicated on the label.



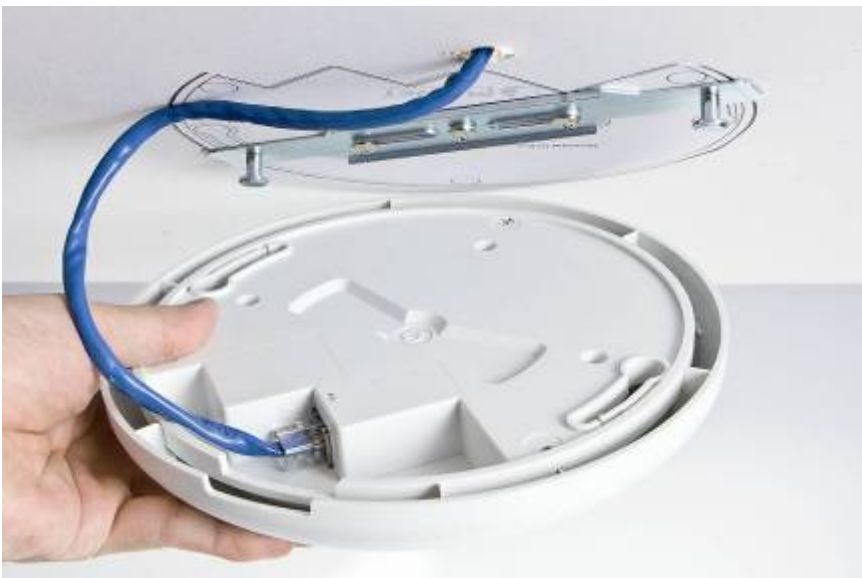
Figure 3-1 WDAP-C7200AC Installation Diagram 1

**Step 2.** Take the mounting bracket, put it on the target place by aligning the holes and fix it with the supplied screws.



**Figure 3-2** WDAP-C7200AC Installation Diagram 2

**Step 3.** Plug the RJ45 Ethernet cable into the PoE port of the WDAP-C7200AC.



**Figure 3-3** WDAP-C7200AC Installation Diagram 3



**Step 4.** Load the device into the mounting bracket, and make sure the device is mated with two fixed screws. Then, rotate the device clockwise to lock it in position.



**Figure 3-4** WDAP-C7200AC Installation Diagram 4

**Step 5.** Plug the other end of the Ethernet cable into the PoE switch.



※ IEEE 802.3at PoE switch is required.

**Figure 3-5** WDAP-C7200AC Installation Diagram 4

### 3.2.2 Installing the AP – WDAP-W7200AC

**Step 1.** Connect the **2.4GHz antennas** to the RP-SMA connectors of the WDAP-W7200AC that indicates “2.4GHz” on the bottom panel.

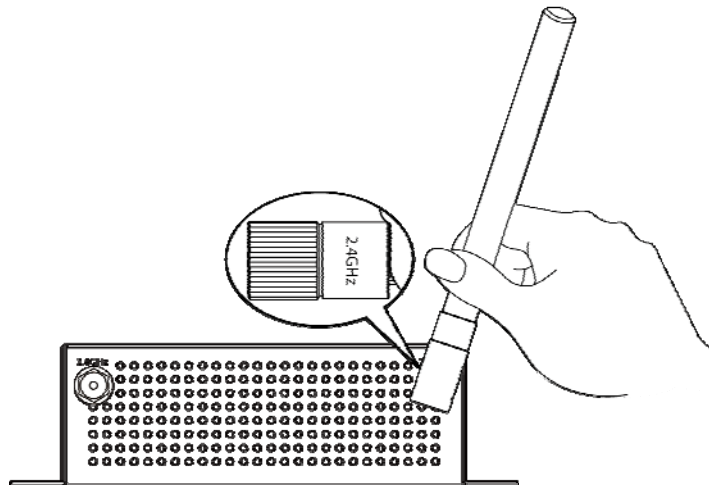


Figure 3-6 WDAP-W7200AC Installation Diagram 1

**Step 2.** Connect the **5GHz antennas** to the RP-SMA connectors of the WDAP-W7200AC that indicates “5GHz” on the top panel.

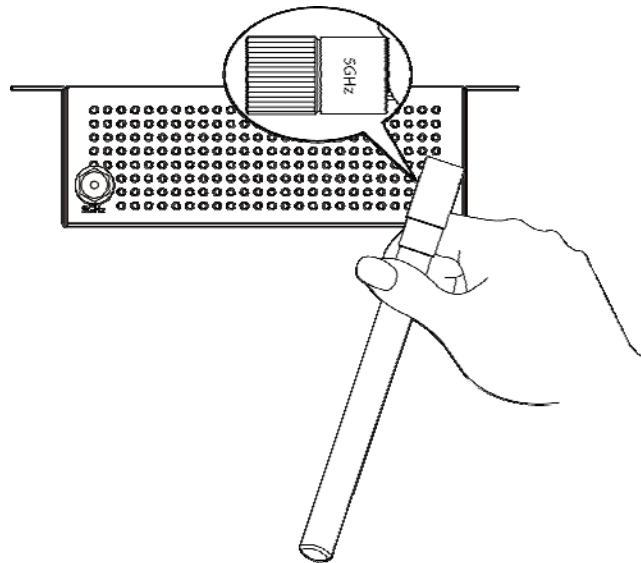


Figure 3-7 WDAP-W7200AC Installation Diagram 2

#### **Step 3. Wall Mount Installation:**

- (1) There are 4 holes with 8mm diameter on the wall; the distance between the 2 holes is 133mm and the line through them must be kept horizontal.
- (2) Install a conductor pipe inside the board hole and flush the edge of the conductor pipe with the wall surface.
- (3) Screw the bolts into the conductor pipe. The WDAP-W7200AC is between bolts and conductor pipe, as shown below.

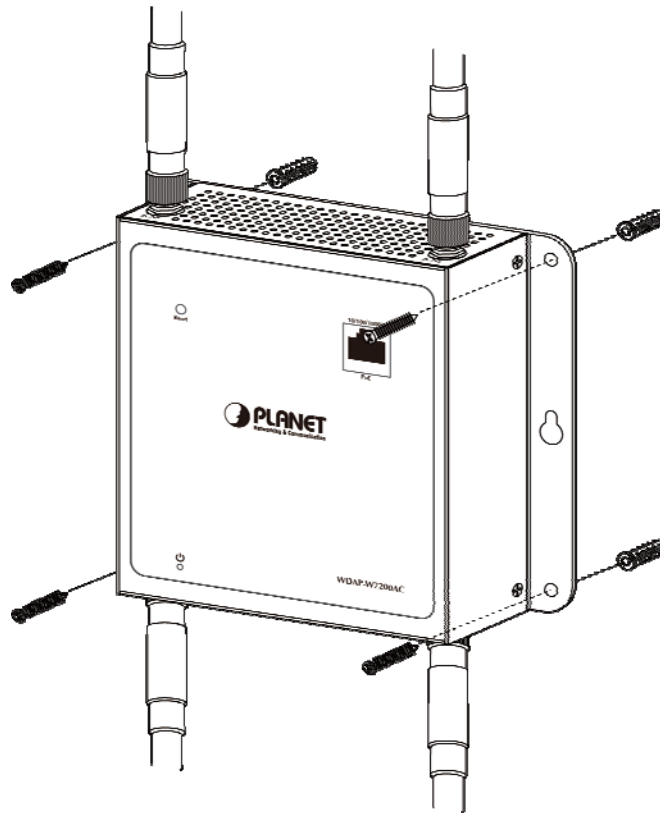


Figure 3-8 WDAP-W7200AC Installation Diagram 3

**Step 4. DIN-Rail Mounting Installation:**

- (1) Screw the DIN-rail on the WDAP-W7200AC
- (2) Lightly push the bottom of DIN-rail into the track
- (3) Check whether the DIN-rail is tightly on the track

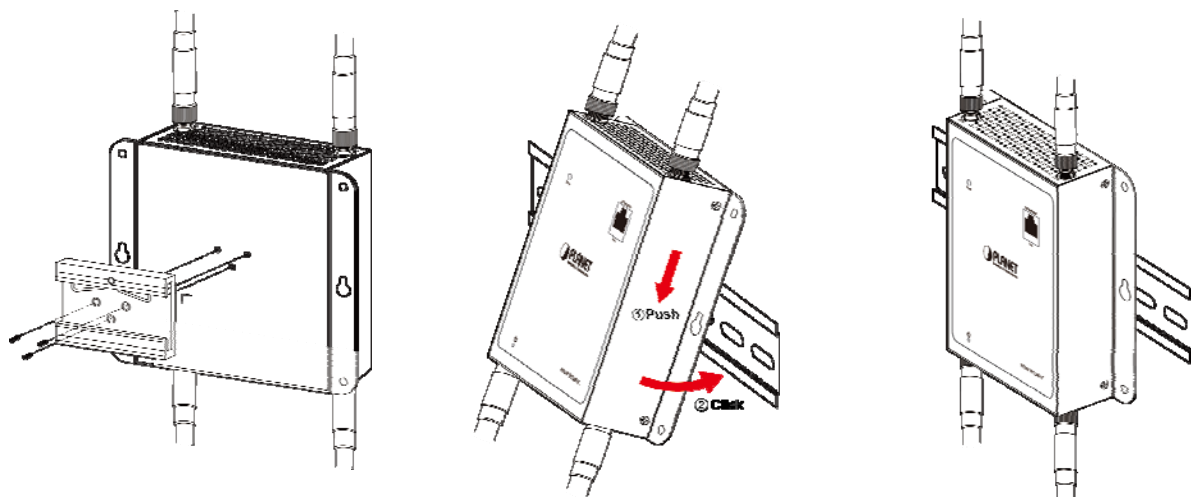


Figure 3-9 WDAP-W7200AC Installation Diagram 4

**Step 5. Magnet Installation:** To install the WDAP-W7200AC on a magnetic surface, simply follow the diagram below:

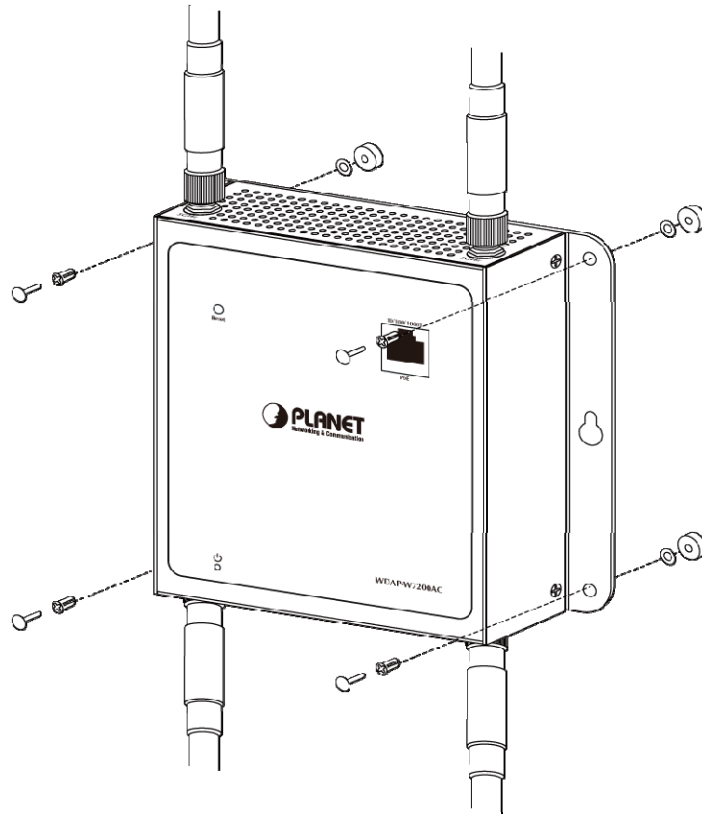


Figure 3-10 WDAP-W7200AC Installation Diagram 5

**Step 6. Plug the Ethernet cable into the PoE port.**

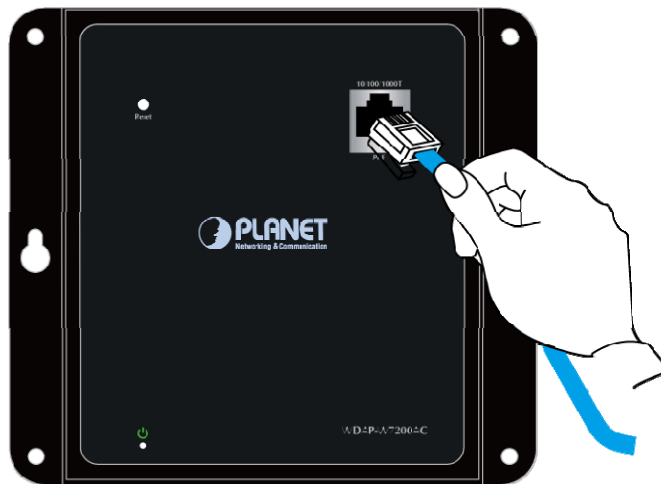
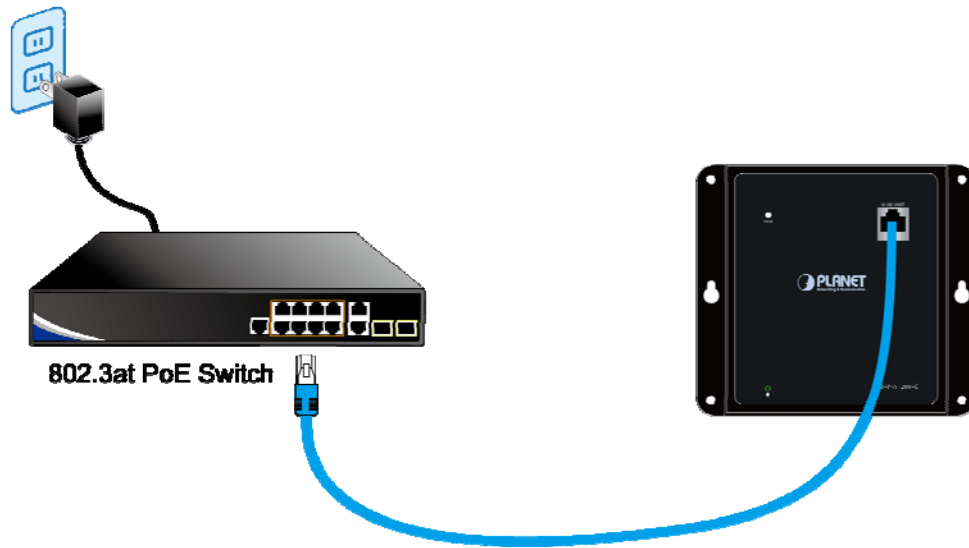


Figure 3-11 WDAP-W7200AC Installation Diagram 6

**Step 7.** Plug the other end of the Ethernet cable into the PoE switch.



※ IEEE 802.3at PoE switch is required.

**Figure 3-12** WDAP-W7200AC Installation Diagram 7

## Chapter 4. Quick Installation Guide

This chapter will show you how to configure the basic functions of your AP within minutes.



A computer with wired Ethernet connection to the Wireless AP is required for the first-time configuration.

### 4.1 Manual Network Setup -- TCP/IP Configuration

The default IP address of the WDAP-C7200AC/WDAP-W7200AC is **192.168.1.253**. And the default Subnet Mask is 255.255.255.0. These values can be changed as you want. In this guide, we use all the default values for description.

Connect the WDAP-C7200AC/WDAP-W7200AC with your PC by an Ethernet cable plugging in LAN port on one side and in LAN port of PC on the other side. Please power on the WDAP-C7200AC/WDAP-W7200AC by PoE switch through the PoE port.

In the following sections, we'll introduce how to install and configure the TCP/IP correctly in **Windows 7**. And the procedures in other operating systems are similar. First, make sure your Ethernet Adapter is working, and refer to the Ethernet adapter manual if needed.

#### 4.1.1 Configuring the IP Address Manually

Summary:

- Set up the TCP/IP Protocol for your PC.
  - Configure the network parameters. The IP address is 192.168.1.xxx (If the default IP address of the WDAP-C7200AC/WDAP-W7200AC is 192.168.1.253, and the DSL router is 192.168.1.254, the "xxx" can be configured to any number from 1 to 252.) and subnet mask is 255.255.255.0.
- 1 Select **Use the following IP address**, and then configure the IP address of the PC.
  - 2 For example, as the default IP address of the WDAP-C7200AC/WDAP-W7200AC is 192.168.1.253 and the DSL router is 192.168.1.254, you may choose from 192.168.1.1 to 192.168.1.252.

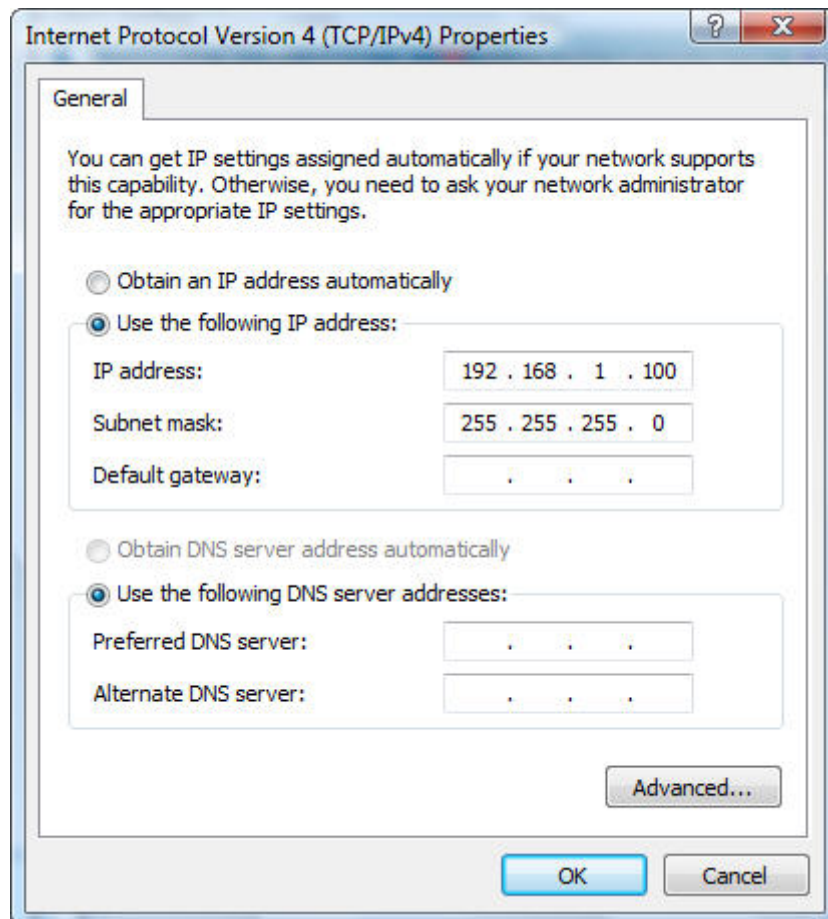


Figure 4-1 TCP/IP Setting

Now click **OK** to save your settings.

Now, you can run the ping command in the **command prompt** to verify the network connection between your PC and the AP. The following example is in **Windows 7** OS. Please follow the steps below:

1. Click on **Start > Run**.
2. Type "**cmd**" in the Search box.

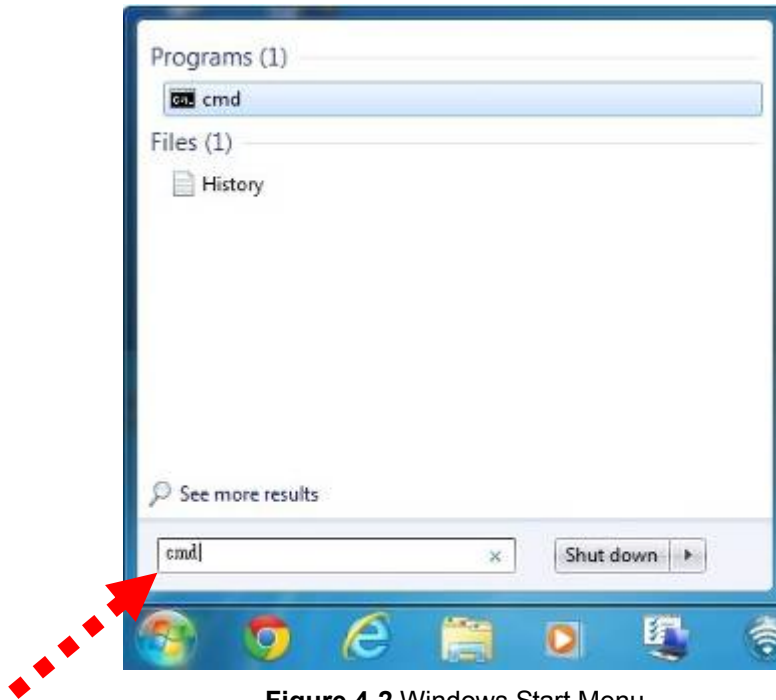


Figure 4-2 Windows Start Menu

3. Open a command prompt, type ping **192.168.1.253** and then press **Enter**.
  - ◆ If the result displayed is similar to **Figure 4-3**, it means the connection between your PC and the AP has been established well.

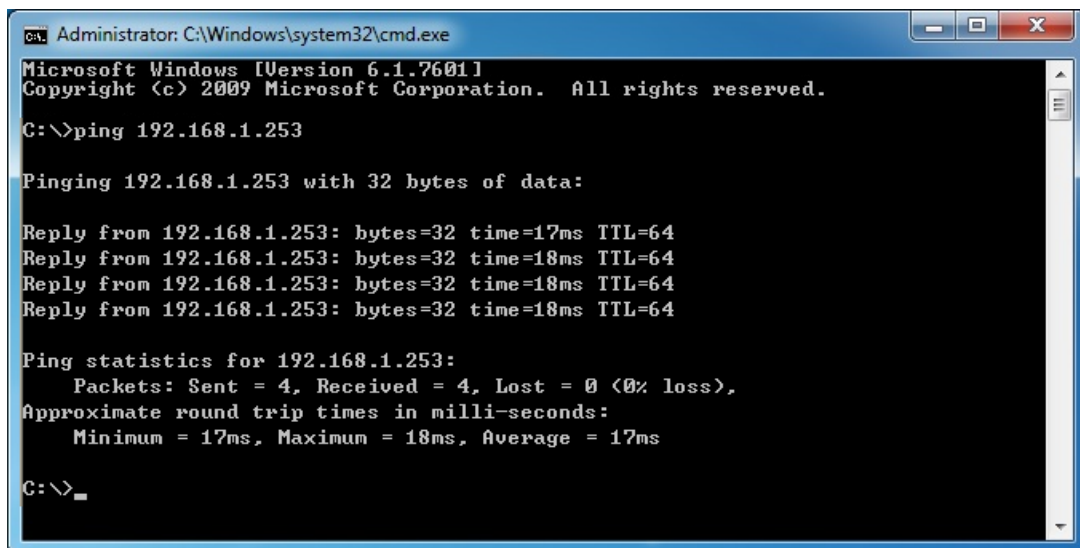
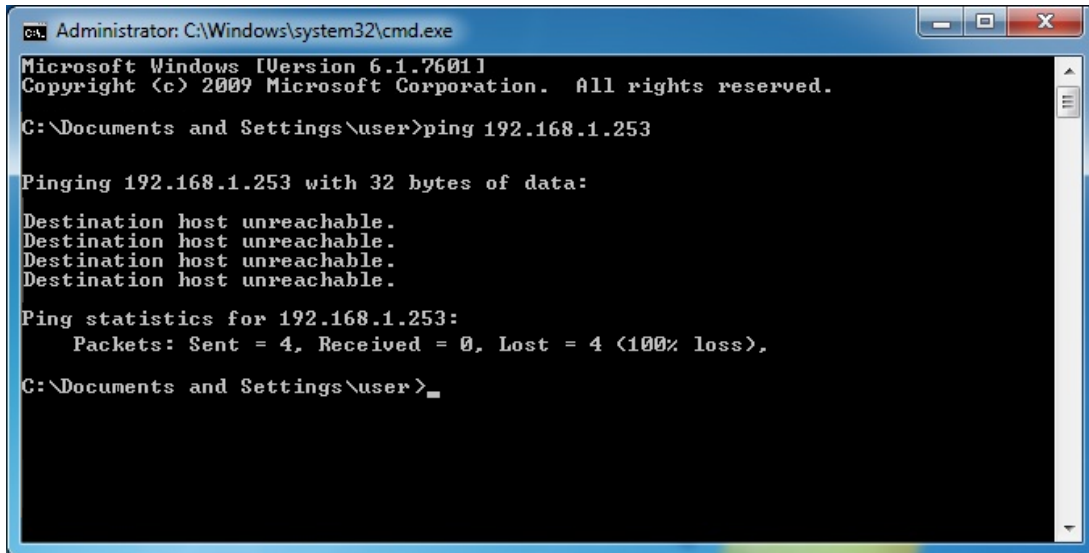


Figure 4-3 Successful Result of Ping Command

- ◆ If the result displayed is similar to **Figure 4-4**, it means the connection between your PC and the AP has failed.





```
Administrator: C:\Windows\system32\cmd.exe
Microsoft Windows [Version 6.1.7601]
Copyright (c) 2009 Microsoft Corporation. All rights reserved.

C:\Documents and Settings\user>ping 192.168.1.253

Pinging 192.168.1.253 with 32 bytes of data:

Destination host unreachable.
Destination host unreachable.
Destination host unreachable.
Destination host unreachable.

Ping statistics for 192.168.1.253:
    Packets: Sent = 4, Received = 0, Lost = 4 (100% loss),

C:\Documents and Settings\user>
```

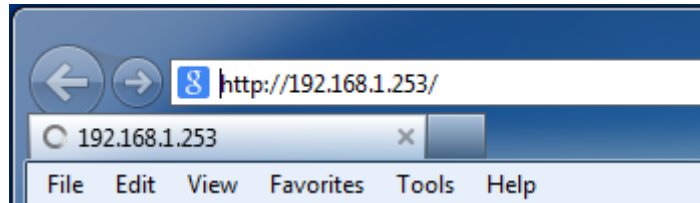
**Figure 4-4** Failed Result of Ping Command

If the address is 0.0.0.0, check your adapter installation, security settings, and the settings on your AP. Some firewall software programs may block a DHCP request on newly installed adapters.

## 4.2 Starting Setup in the Web UI

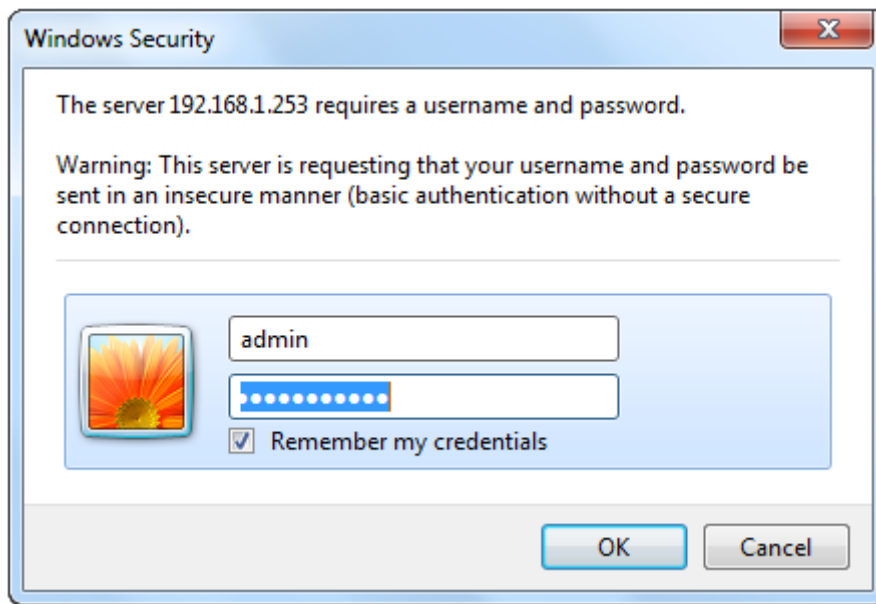
It is easy to configure and manage the AP with the web browser.

**Step 1.** To access the configuration utility, open a web-browser and enter the default IP address <http://192.168.1.253> in the web address field of the browser.



**Figure 4-5** Login by Default IP Address

After a moment, a login window will appear. Enter **admin** for the User Name and Password, both in lower case letters. Then click **OK** or press the **Enter** key.



**Figure 4-6** Login Window

Default IP Address: **192.168.1.253**

Default User Name: **admin**

Default Password: **admin**



Note

If the above screen does not pop up, it may mean that your web-browser has been set to a proxy. Go to Tools menu> Internet Options> Connections> LAN Settings on the screen that appears, uncheck **Using Proxy** and click **OK** to finish it.

# Chapter 5. Configuring the AP

This chapter delivers a detailed presentation of AP's functionalities and features 8 main items below, allowing you to manage the AP with ease. The screen shots use the WDAP-C7200AC as an example.

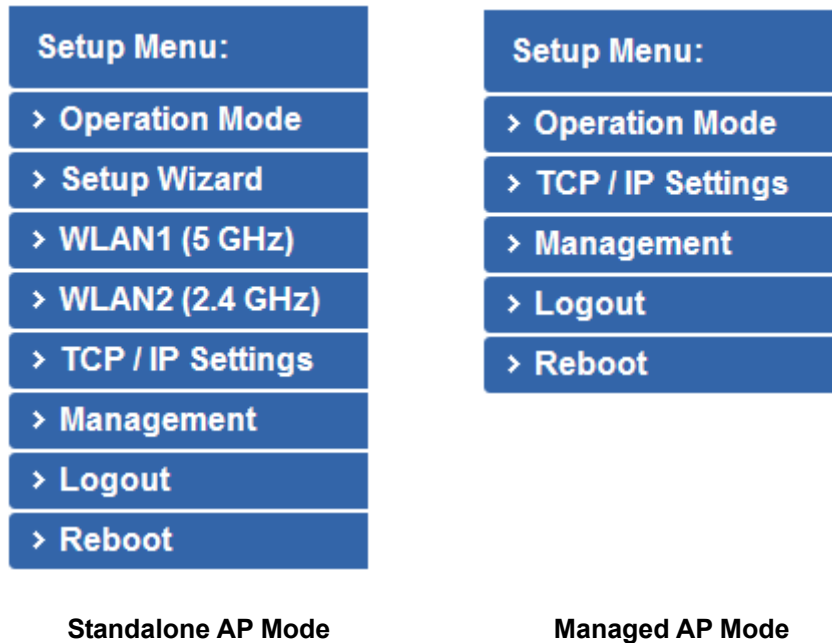
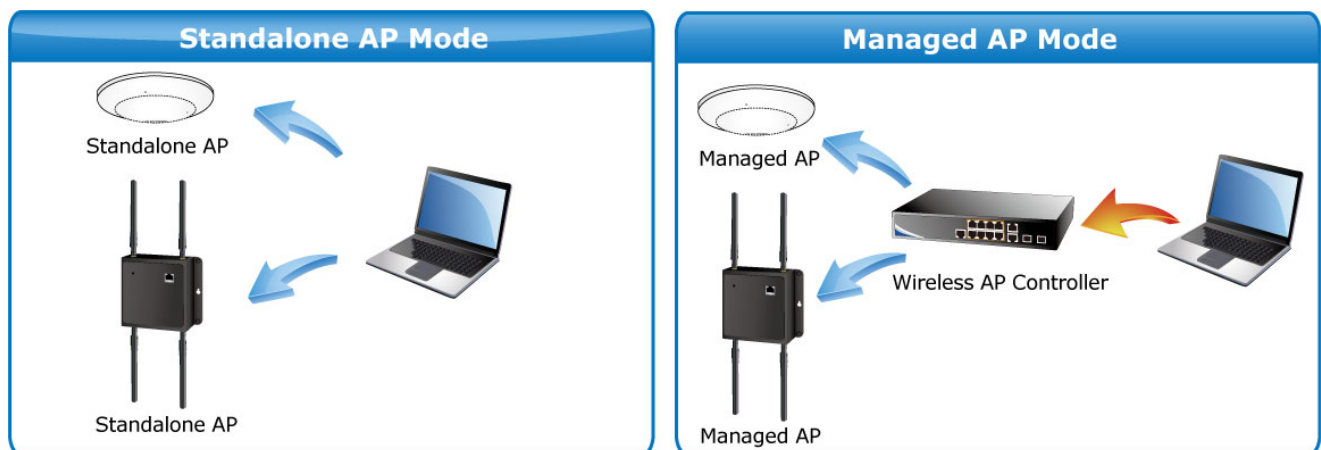


Figure 5-1 Main Menu

During operation, if you are not clear about a certain feature, you can refer to the "Help" section at the right side of the screen to read all the related helpful information.

## 5.1 Operation Mode

The Operation Mode section guides you to configuring the WDAP-C7200AC/WDAP-W7200AC to **Standalone AP** or **Managed AP**. When switching the operation mode to **Managed AP**, the administrator will be able to manage the AP by PLANET Wireless AP Controller. To configure the managed AP by PLANET Wireless AP Controller, please refer to the WAPC-1232HP AP Management user's manual.



**Setup Menu:**

- > Operation Mode
- > Setup Wizard
- > WLAN1 (5 GHz)
- > WLAN2 (2.4 GHz)
- > TCP / IP Settings
- > Management
- > Logout
- > Reboot

## Operation Mode

AP Operation mode configuration is used to configure the managed AP administrative mode.

Standalone AP

Managed AP

In Mode **Standalone AP**, the AP acts as an individual AP in the network, and you manage it by using the Administrator Web User Interface (UI), or SNMP.

In Mode **Managed AP**, the AP is part of the PLANET Wireless AP controller System, and you manage it by using the WAPC Wireless Switch.

AP Controller IP Address

**Note:** After you configure the settings on the AP Operation Mode page, you must click Apply button to apply the changes and to save the settings. Changing some settings might cause the AP to stop and restart system processes. If this happens, wireless clients will temporarily lose connectivity. We recommend that you change AP settings when WLAN traffic is low.

**Operation Mode**

**Standalone AP**  
In Standalone AP, the AP acts as an individual AP in the network, and you manage it by using the Administrator Web User Interface (UI), or SNMP.

**Managed AP**  
In Managed AP, the AP is part of the PLANET Wireless AP controller System, and you manage it by using the WAPC Wireless Switch.

Figure 5-2 Operation Mode

The page includes the following fields:

Object	Description
Standalone AP	In Standalone AP, the AP acts as an individual AP in the network, and you manage it by using the Administrator Web User Interface (UI), or SNMP.
Managed AP	In Managed AP, the AP is part of the PLANET Wireless AP controller System, and you manage it by using the WAPC Wireless AP controller.
AP Controller IP Address	Check this option and enter the IP address of the AP controller that user specifies. The default "0.0.0.0" means any AP controller existed in the local network can control this AP.
Apply Change	Click " <b>Apply Change</b> " to save and apply the settings.
Reset	Click " <b>Reset</b> " to erase all settings.



After you configure the settings on the AP Operation Mode page, you must click **Apply** to apply the changes and to save the settings. Changing some settings might cause the AP to stop and restart system processes. If this happens, wireless clients will temporarily lose connectivity. We recommend that you change AP settings when WLAN traffic is low.



Please back up the configuration settings before switching from the Standalone AP mode to the Managed AP mode.

All the configurations will be erased and at the same time, the system will return to the factory default settings once it is reverted to the Standalone AP mode.

## 5.2 Setup Wizard

The Setup Wizard will guide the user to configuring the WDAP-C7200AC/WDAP-W7200AC easily and quickly. Select **Setup Wizard** on the left side of the screen and by clicking on Next on the Setup Wizard screen shown below, you will then name your WDAP-C7200AC/WDAP-W7200AC and set up its security.

<b>Setup Menu:</b>	<h3>Setup Wizard</h3>	<p><b>Setup Wizard</b></p> <p>Click on the "Wizard" page and it will guide you to setting up your AP step by step in a simple way. The steps include LAN Interface Setup, Time Zone, Wireless Basics and Wireless Encryption Setting.</p> <p><b>LAN Interface</b> Set up the TCP/IP address of the access point, including its LAN IP Address, subnet mask and gateway.</p>
> Operation Mode	<p>The Wizard will guide you the through following steps. Begin by clicking on Next.</p> <ol style="list-style-type: none"> <li>1. Setup LAN Interface</li> <li>2. Choose your Time Zone</li> <li>3. Wireless LAN Setting</li> <li>4. Wireless Security Setting</li> </ol> <div style="text-align: right; margin-top: 20px;"> <input type="button" value="Next&gt;&gt;"/> </div>	
> Setup Wizard		
> WLAN1 (5 GHz)		
> WLAN2 (2.4 GHz)		
> TCP / IP Settings		
> Management		
> Logout		
> Reboot		

Figure 5-3 Setup Wizard

### Step 1: LAN Interface Setup



Figure 5-4 LAN Interface Setup Topology

### LAN Interface Setup

---

IP Address:

Subnet Mask:

Default Gateway:

Figure 5-5 Wizard – LAN Interface Setup

The page includes the following fields:

Object	Description
IP Address	Displays the current IP address of the AP. (Default = 192.168.1.253)
Subnet Mask	Displays LAN mask of the AP. (Default = 255.255.255.0)
Default Gateway	IP address of the associated router. (Default = 192.168.1.254)

**Step 2: Time Zone Setting**

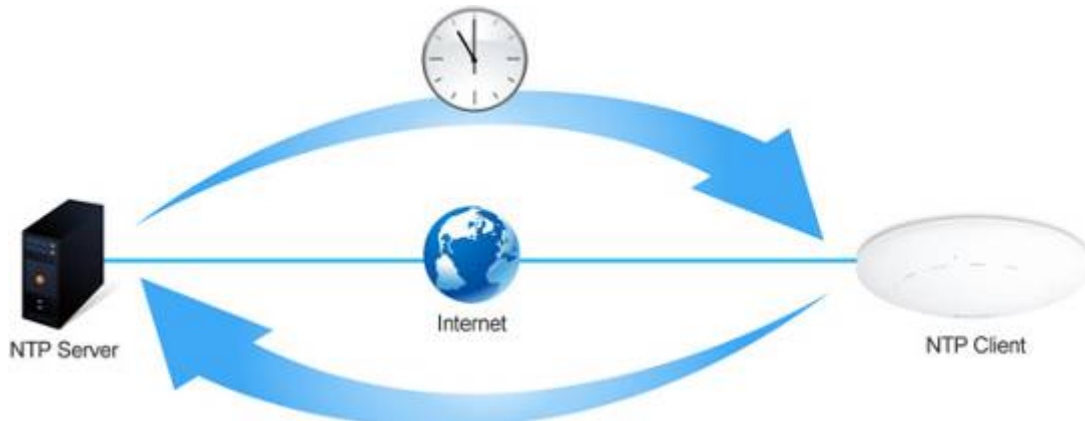


Figure 5-6 Time Zone Setup Topology

### Time Zone Setting

Enable NTP client update

Automatically Adjust Daylight Saving

Time Zone Select : (GMT-08:00)Pacific Time (US & Canada); Tijuana

NTP server : 192.5.41.209 - North America

Figure 5-7 Wizard – Time Zone Setup

The page includes the following fields:

Object	Description
Enable NTP Client Update	Check this box to connect NTP Server and synchronize internet time.
Automatically Adjust Daylight Saving	Check this box and system will adjust the daylight saving automatically.
Time Zone Select	Select the Time Zone from the drop-down menu.
NTP Server	Select the NTP Server from the drop-down menu.
Enable NTP Client Update	Check this box to connect NTP Server and synchronize internet time.

### Step 3: Wireless 5GHz Basic Settings

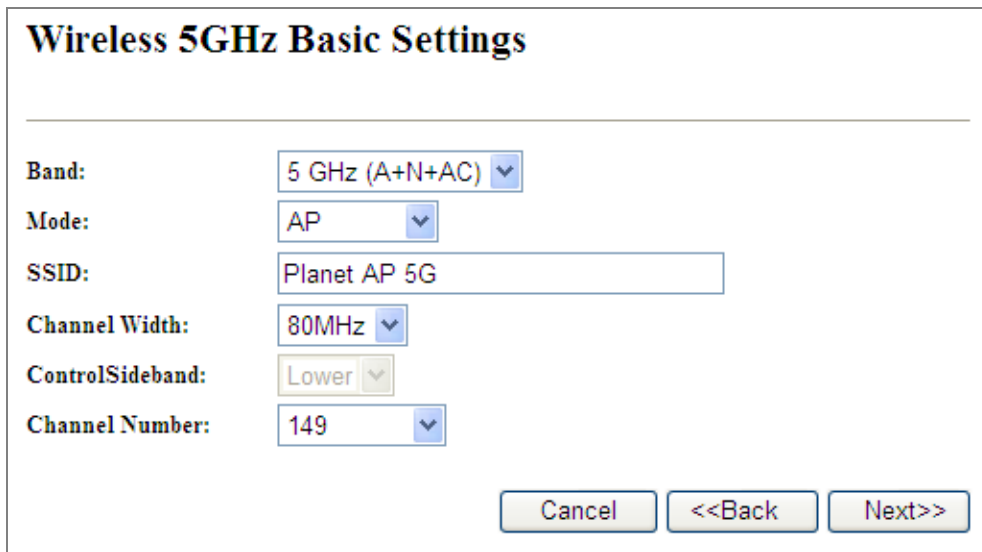


Figure 5-8 Wizard – Wireless 5GHz Basic Settings

The page includes the following fields:

Object	Description
Band	Supports 802.11a, 802.11n, 802.11ac and mixed mode. Please choose its band according to your clients.
Mode	Supports AP, Client, WDS and AP+WDS mode.
SSID	Service Set Identifier identifies your wireless network.
Channel Width	Select 80MHz if you use 802.11ac; select 40MHz if you use 802.11n; otherwise, 20MHz is for the 802.11a mode.
Control Sideband	It is only valid when you choose a 40MHz channel width.
Channel Number	Indicates the channel setting for the AP.

### Step 4: Wireless 5GHz Security Settings

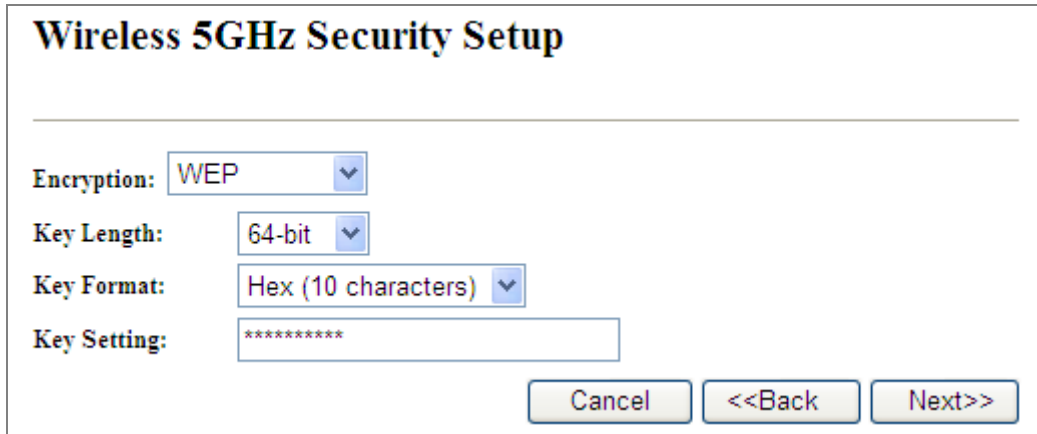
Secure your wireless network by turning on the WPA or WEP security feature on the router. For this section, you can set **WEP** and **WPA-PSK** security mode.



Figure 5-9 Wizard – Wireless 5GHz Security Setup

■ **Encryption: WEP**

The following picture shows how to set the WEP security.



The screenshot shows a web interface titled "Wireless 5GHz Security Setup". It contains the following fields and controls:

- Encryption:** A dropdown menu with "WEP" selected.
- Key Length:** A dropdown menu with "64-bit" selected.
- Key Format:** A dropdown menu with "Hex (10 characters)" selected.
- Key Setting:** A text input field containing "\*\*\*\*\*".
- Navigation buttons: "Cancel", "<<Back", and "Next>>" are located at the bottom right.

**Figure 5-10** 5GHz Wireless Security Setup – WEP Setting

The page includes the following fields:

Object	Description
Key Length	WEP supports 64-bit or 128-bit security key.
Key Format	User can enter key in ASCII or Hex format.
Key Setting	Enter the key whose format is limited by the key format, ASCII or Hex.

■ **Encryption: WPA-PSK**

The following picture shows how to set up **WPA-PSK** security. You can select **WPA (TKIP)**, **WPA2 (AES)** and **Mixed mode**.



The screenshot shows a web interface titled "Wireless 5GHz Security Setup". It contains the following fields and controls:

- Encryption:** A dropdown menu with "WPA2(AES)" selected.
- Pre-Shared Key Format:** A dropdown menu with "Passphrase" selected.
- Pre-Shared Key:** An empty text input field.
- Navigation buttons: "Cancel", "<<Back", and "Next>>" are located at the bottom right.

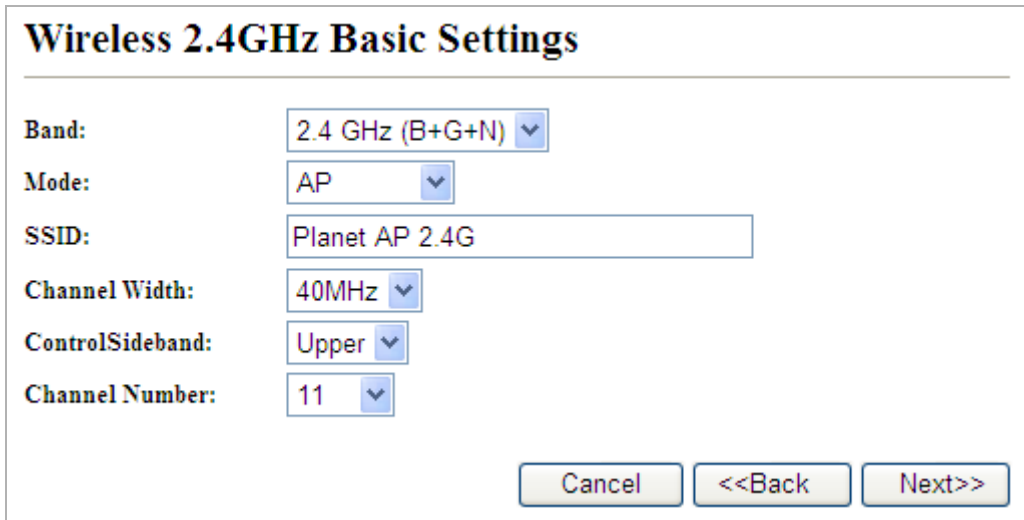
**Figure 5-11** 5GHz Wireless Security Setup – WPA Setting

The page includes the following fields:

Object	Description
Pre-shared Key Format	Specify the format of the key, pass phrase or hex.
Pre-shared Key	Enter the key whose format is limited by the key format.



**Step 5: Wireless 2.4GHz Basic Settings**



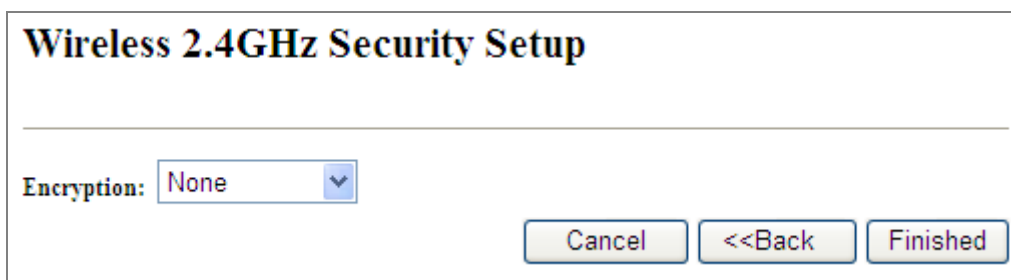
**Figure 5-12** Wizard – Wireless 2.4GHz Basic Settings

The page includes the following fields:

Object	Description
<b>Band</b>	Supports 802.11b, 802.11g, 802.11n and mixed mode. Please choose its band according to your clients.
<b>Mode</b>	Supports AP, Client, WDS and AP+WDS mode.
<b>SSID</b>	Service Set Identifier identifies your wireless network.
<b>Channel Width</b>	Select 40MHz if you use 802.11n, otherwise, 20MHz is for the 802.11b/g mode.
<b>Control Sideband</b>	It is only valid when you choose a 40MHz channel width.
<b>Channel Number</b>	Indicates the channel setting for the AP.

**Step 6: Wireless 2.4GHz Security Settings**

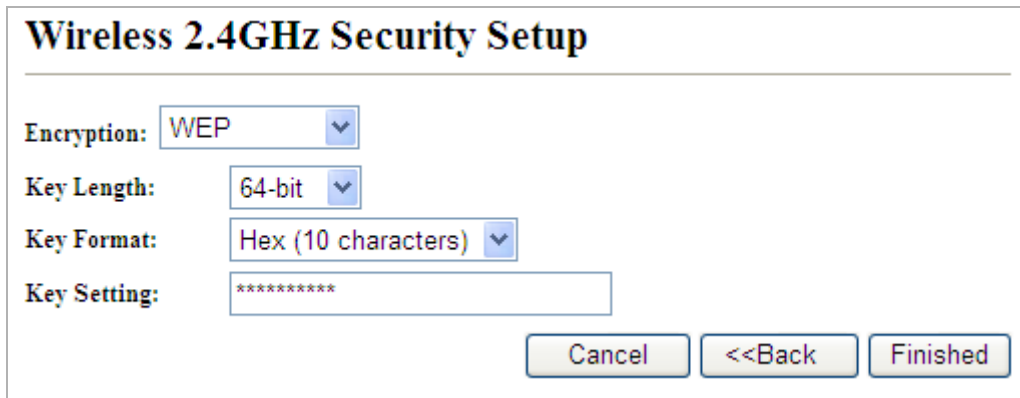
Secure your wireless network by turning on the WPA or WEP security feature on the router. For this section, you can set **WEP** and **WPA-PSK** security mode.



**Figure 5-13** Wizard – Wireless 2.4GHz Security Setup

■ **Encryption: WEP**

The following picture shows how to set the WEP security.



The screenshot shows a web interface titled "Wireless 2.4GHz Security Setup". It contains the following fields and controls:

- Encryption:** A dropdown menu with "WEP" selected.
- Key Length:** A dropdown menu with "64-bit" selected.
- Key Format:** A dropdown menu with "Hex (10 characters)" selected.
- Key Setting:** A text input field containing "\*\*\*\*\*".
- Buttons:** "Cancel", "<<Back", and "Finished" buttons are located at the bottom right.

Figure 5-14 2.4GHz Wireless Security Setup – WEP Setting

The page includes the following fields:

Object	Description
Key Length	WEP supports 64-bit or 128-bit security key.
Key Format	User can enter key in ASCII or Hex format.
Key Setting	Enter the key whose format is limited by the key format, ASCII or Hex.

■ **Encryption: WPA-PSK**

The following picture shows how to set **WPA-PSK** security. You can select **WPA (TKIP)**, **WPA2 (AES)** and **Mixed mode**.



The screenshot shows a web interface titled "Wireless 2.4GHz Security Setup". It contains the following fields and controls:

- Encryption:** A dropdown menu with "WPA2(AES)" selected.
- Pre-Shared Key Format:** A dropdown menu with "Passphrase" selected.
- Pre-Shared Key:** An empty text input field.
- Buttons:** "Cancel", "<<Back", and "Finished" buttons are located at the bottom right.

Figure 5-15 2.4GHz Wireless Security Setup – WPA Setting

The page includes the following fields:

Object	Description
Pre-shared Key Format	Specify the format of the key, pass phrase or hex.
Pre-shared Key	Enter the key whose format is limited by the key format.

Click **Finished** to make your wireless configuration effective and finish the **Setup Wizard**.



**Figure 5-16** Setup Wizard - Finished

After rebooting, please check whether you can access the Internet or not on the **“Status”** page.

### 5.3 TCP/IP Settings

This page is used to configure the parameters for local area network which connects to the LAN port of your AP. Here you may change the setting for IP address, subnet mask, DHCP, etc.

#### 5.3.1 LAN Settings

On the LAN Settings page, you can configure the IP parameters of the LAN on the screen as shown below.

### LAN Interface Setup

This page is used to configure the parameters for local area network which connects to the LAN port of your Access Point. Here you may change the setting for IP address, subnet mask, DHCP, etc..

IP Address:	<input type="text" value="192.168.1.253"/>	
Subnet Mask:	<input type="text" value="255.255.255.0"/>	
Default Gateway:	<input type="text" value="192.168.1.254"/>	
DHCP:	<input type="button" value="Disabled"/>	
DHCP Client Range:	<input type="text" value="192.168.1.100"/> - <input type="text" value="192.168.1.200"/>	<input type="button" value="Show Client"/>
DHCP Lease Time:	<input type="text" value="480"/> (1 ~ 10080 minutes)	
Static DHCP:	<input type="button" value="Set Static DHCP"/>	
Domain Name:	<input type="text" value="Planet"/>	
802.1d Spanning Tree:	<input type="button" value="Disabled"/>	
Clone MAC Address:	<input type="text" value="000000000000"/>	
UPnP Enable:	<input type="button" value="Enabled"/>	

Figure 5-17 LAN Setting

The page includes the following fields:

Object	Description
<b>IP Address</b>	The default LAN IP address of the WDAP-C7200AC/WDAP-W7200AC is <b>192.168.1.253</b> . You can change it according to your request.

<b>Subnet Mask</b>	Default is <b>255.255.255.0</b> . You can change it according to your request.
<b>Default Gateway</b>	Default is <b>192.168.1.253</b> . You can change it according to your request.
<b>DHCP</b>	You can select a <b>Disabled, Client, and Server</b> . Default is <b>Disabled</b> , meaning the WDAP-C7200AC/WDAP-W7200AC must connect to a router to assign IP addresses to clients.
<b>DHCP Client Range</b>	For the <b>Server</b> mode, you must enter the DHCP client IP address range in the field. And you can click " <b>Show Client</b> " to show the Active DHCP Client Table.
<b>Static DHCP</b>	Click " <b>Set Static DHCP</b> " and you can reserve some IP addresses for those network devices with the specified MAC addresses anytime when they request IP addresses.
<b>Domain Name</b>	Default is <b>Planet</b> .
<b>802.1d Spanning Tree</b>	You can enable or disable the Spanning Tree function.
<b>Clone MAC Address</b>	You can input an MAC address here for using clone function.
<b>UPnP Enable</b>	You can enable or disable the UPnP function. The UPnP feature allows the devices, such as Internet computers, to access the local host resources or devices as needed. UPnP devices can be automatically discovered by the UPnP service application on the LAN.



If you change the IP address of LAN, you must use the new IP address to login the AP.



When the IP address of the WDAP-C7200AC/WDAP-W7200AC is changed, the clients on the network often need to wait for a while or even reboot before they can access the new IP address. For an immediate access to the AP, please flush the netbios cache on the client computer by running the "nbtstat -r" command before using the device name of the WDAP-C7200AC/WDAP-W7200AC to access its Web Management page.

## 5.4 WLAN1 (5GHz)

The wireless menu of WLAN1 (5GHz) contains submenus of the settings about wireless network. Please refer to the following sections for the details.

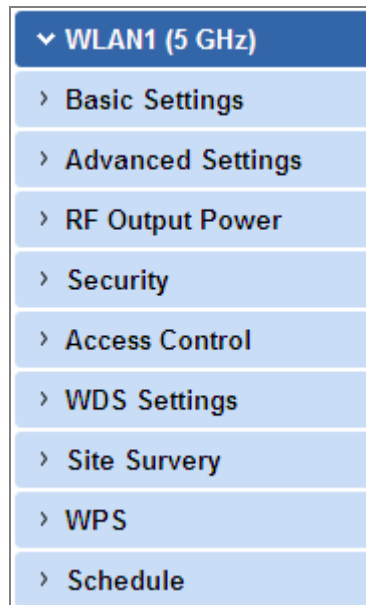


Figure 5-18 5GHz Wireless Main Menu

### 5.4.1 Basic Settings

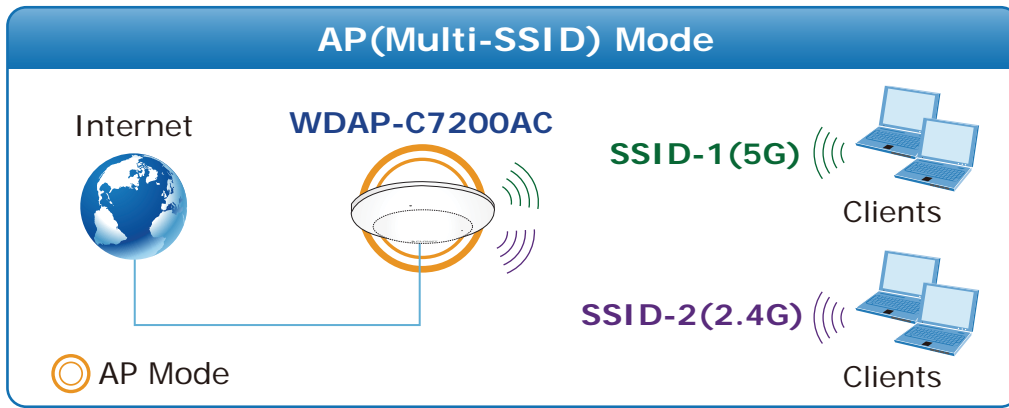
Choose menu “**WLAN1 (5GHz) → Basic Settings**” and you can configure the 5GHz basic settings for the wireless network on this page. After the configuration is done, please click “**Apply Changes**” to save the settings.

First of all, the wireless AP supports multiple wireless modes for different network applications, which include:

- **AP**
- **Multiple SSIDs**
- **Universal Repeater**
- **Client**
- **WDS**
- **AP+WDS**

It is so easy to combine the WDAP-C7200AC/WDAP-W7200AC with the existing wired network. The WDAP-C7200AC/WDAP-W7200AC definitely provides a total network solution for the home and the SOHO users.

- **AP**  
Standard **Access Point**



### Wireless Basic Settings - WLAN1 (5 GHz)

This page is used to configure the parameters for wireless LAN clients which may connect to your Access Point. Here you may change wireless encryption settings as well as wireless network parameters.

---

Disable Wireless LAN Interface

Band:  ▾

Mode:  ▾

Network Type:  ▾

SSID:

Channel Width:  ▾

Control Sideband:  ▾

Channel Number:  ▾

Broadcast SSID:  ▾

WMM:  ▾

Data Rate:  ▾

TX restrict:  Mbps (0:no restrict)

RX restrict:  Mbps (0:no restrict)

Associated Clients:

Enable Mac Clone (Single Ethernet Client)

Enable Universal Repeater Mode (Acting as AP and client simultaneously)

SSID of Extended

Interface:

Figure 5-19 5GHz Wireless Basic Settings of AP

The page includes the following fields:

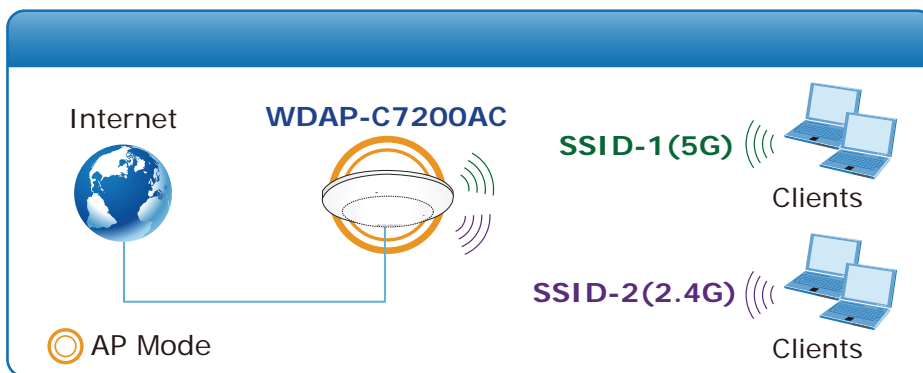
Object	Description
<b>Disable Wireless LAN Interface</b>	Check the box to disable the wireless function.
<b>Band</b>	<p>Select the desired mode. Default is “<b>5GHz (A+N+AC)</b>”. It is strongly recommended that you set the Band to “<b>5GHz (A+N+AC)</b>”, and all of 802.11a, 802.11n, and 802.11ac wireless stations can connect to the WDAP-C7200AC/WDAP-W7200AC.</p> <ul style="list-style-type: none"> <li>■ <b>5 GHz (A)</b>: 802.11a mode, rate is up to 54Mbps</li> <li>■ <b>5 GHz (N)</b>: 802.11n mode, rate is up to 300Mbps</li> <li>■ <b>5 GHz (AC)</b>: 802.11n mode, rate is up to 867Mbps(2T2R)</li> <li>■ <b>5 GHz (A+N)</b>: 802.11a/n mode, rate is up to 300Mbps</li> <li>■ <b>5 GHz (N+AC)</b>: 802.11n/ac mode, rate is up to 300Mbps or 867Mbps</li> <li>■ <b>5 GHz (A+N+AC)</b>: 802.11a/n/ac mode, rate is up to 54Mbps, 300Mbps, or 867Mbps</li> </ul>
<b>Mode</b>	<p>There are four kinds of wireless mode selections:</p> <ul style="list-style-type: none"> <li>■ <b>AP</b></li> <li>■ <b>Client</b></li> <li>■ <b>WDS</b></li> <li>■ <b>AP+WDS</b></li> </ul> <p>If you select WDS or AP+WDS, please click “<b>WDS Settings</b>” in the submenu for the related configuration. Furthermore, click “<b>Multiple AP</b>” to enable multiple SSID functions.</p>
<b>SSID</b>	<p>It is the ID of the wireless network. User can access the wireless network through it only. However, if you switch to Client Mode, this field becomes the SSID of the AP you want to connect with.</p> <p>Default: <b>Planet AP 5G</b></p>
<b>Channel Width</b>	You can select <b>20MHz</b> , <b>40MHz</b> or <b>80MHz</b> .
<b>Channel Number</b>	<p>You can select the operating frequency of wireless network.</p> <p>Default: <b>149</b></p>
<b>Broadcast SSID</b>	<p>If you enable “<b>Broadcast SSID</b>”, every wireless station located within the coverage of the AP can discover its signal easily. If you are building a public wireless network, enabling this feature is recommended. In private network, disabling “<b>Broadcast SSID</b>” can provide better wireless network security.</p> <p>Default is “<b>Enabled</b>”.</p>
<b>Data Rate</b>	Set the wireless data transfer rate to a certain value. Since most of wireless devices will negotiate with each other and pick a proper data transfer rate automatically, <b>it's not necessary to change this value</b>



	<p><b>unless you know what will happen after modification.</b></p> <p>Default is <b>“Auto”</b>.</p>
<b>Associated Clients</b>	Click <b>“Show Active Clients”</b> to show the status table of active wireless clients.
<b>Enable Universal Repeater Mode</b> <b>(Acting as AP and client simultaneously)</b>	Universal Repeater is a technology used to extend wireless coverage. To enable Universal Repeater Mode, check the box and enter the SSID you want to broadcast in the field below. Then please click <b>“Security”</b> in the submenu for the related settings of the AP you want to connect with.

■ **Multiple-SSID**

Enabling multiple-SSID can broadcast multiple WLAN SSIDs using virtual interfaces. You can have different encryption settings for each WLAN and you can restrict what they have access to.



Choose menu **“WLAN1 (5GHz) → Basic Settings → Multiple AP”** to configure the device as a general wireless access point with multiple SSIDs.

### Wireless Basic Settings - WLAN1 (5 GHz)

This page is used to configure the parameters for wireless LAN clients which may connect to your Access Point. Here you may change wireless encryption settings as well as wireless network parameters.

---

Disable Wireless LAN Interface

Band: 5 GHz (A+N+AC) ▼

Mode: AP ▼ MultipleAP

Network Type: Infrastructure ▼

SSID: Planet AP 5G Add to Profile

**Figure 5-20** 5GHz Wireless Basic Settings – Multiple APs

The device supports up to four multiple Service Set Identifiers. You can go back to the **Basic Settings** page to set the Primary SSID. The SSID's factory default setting is **Planet 5G VAP1~4 (Multiple-SSID 1~4)**. The SSID can be easily changed to connect to an existing wireless network or to establish a new wireless network. When the information for the new SSID is finished, click **Apply Changes** to let your changes take effect.

**Multiple APs Multiple APs - WLAN1 (5 GHz)**

This page shows and updates the wireless setting for multiple APs.

No.	Enable	Band	SSID	Data Rate	Broadcast SSID	WMM	Access	Tx Restrict (Mbps)	Rx Restrict (Mbps)	Active Client List	WLAN mode
AP1	<input checked="" type="checkbox"/>	5 GHz (A+N+AC)	Planet 5G VAP	Auto	Enabled	Enabled	LAN	0	0	Show	AP
AP2	<input checked="" type="checkbox"/>	5 GHz (A+N+AC)	Planet 5G VAP	Auto	Enabled	Enabled	LAN	0	0	Show	AP
AP3	<input checked="" type="checkbox"/>	5 GHz (A+N+AC)	Planet 5G VAP	Auto	Enabled	Enabled	LAN	0	0	Show	AP
AP4	<input checked="" type="checkbox"/>	5 GHz (A+N+AC)	Planet 5G VAP	Auto	Enabled	Enabled	LAN	0	0	Show	AP

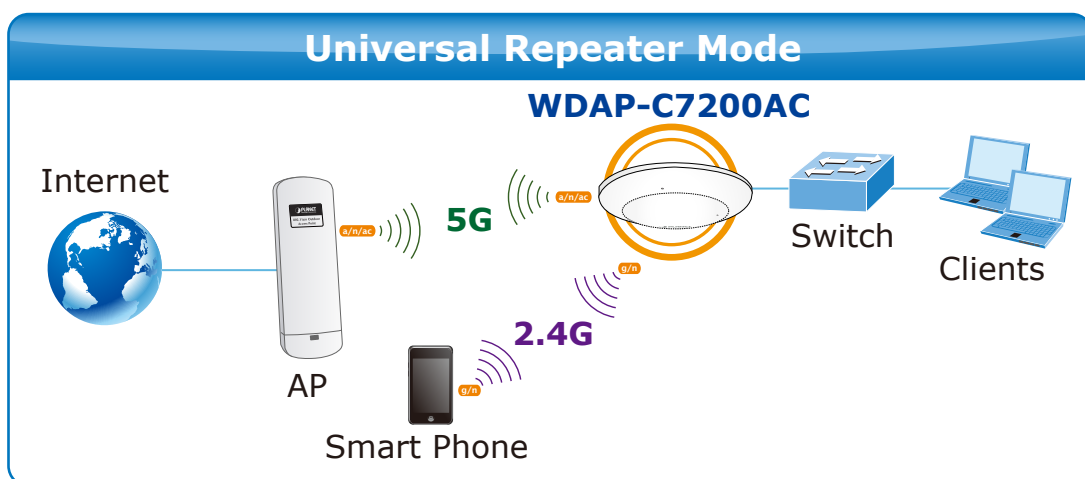
Apply Changes    Reset

Figure 5-21 5GHz Multiple-SSID

Once you have applied and saved those settings, you can then go to the **“WLAN1 (5GHz) → Security”** page on the AP to set up security settings for each of the SSIDs.

■ **Universal Repeater**

This mode allows the AP with its own BSS to relay data to a root AP to which it is associated with WDS disabled. The wireless repeater relays signal between its stations and the root AP for greater wireless range.



1. Example of how to configure **Universal Repeater Mode**. Please take the following steps:  
To configure each wireless parameter, please go to the **“WLAN1 (5GHz) → Basic Settings”** page.

**Step 1.** Configure wireless mode to **“AP”** and then check **“Enable Universal Repeater Mode (Acting as AP”**

**Step 1.** Configure wireless mode to **“AP”** and then check **“Enable Universal Repeater Mode (Acting as AP”**

and client simultaneously)". Click "Apply Changes" to take effect.

### Wireless Basic Settings - WLAN1 (5 GHz)

Disable Wireless LAN Interface

Band: 5 GHz (A+N+AC) ▾

**Mode:** AP ▾ MultipleAP

Network Type: Infrastructure ▾

SSID: Planet AP 5G Add to Profile

Enable Mac Clone (Single Ethernet Client)

**Enable Universal Repeater Mode (Acting as AP and client simultaneously)**

SSID of Extended Add to Profile

Interface: Planet Rpt0


Apply Changes Reset

Figure 5-22 5GHz Universal Repeater-1


**Step 2.** Go to **5GHz Site Survey** page to find the root AP. Select the root AP that you want to repeat the signal and then click "Next".

### Wireless Site Survey - WLAN1 (5GHz)


This page provides tool to scan the wireless network. If any Access Point or IBSS is found, you could choose to connect it manually when client mode is enabled.



Wireless Router



Recommended Signal Strength



Range Extender

Site Survey

SSID	BSSID	Channel	Type	Encrypt	Signal	Select
WDRT-1200AC-5G	00:30:4f:74:20:08	149 (A+N+AC)	AP	WPA2-PSK	67	<input type="radio"/>
Default_5G_1	00:30:4f:b4:c4:a8	157 (A+N)	AP	WPA2-PSK	30	<input checked="" type="radio"/>

Next>>

Figure 5-23 5GHz Universal Repeater-2

**Step 3.** Select the correct encryption method and enter the security key. Then, click “Connect”.

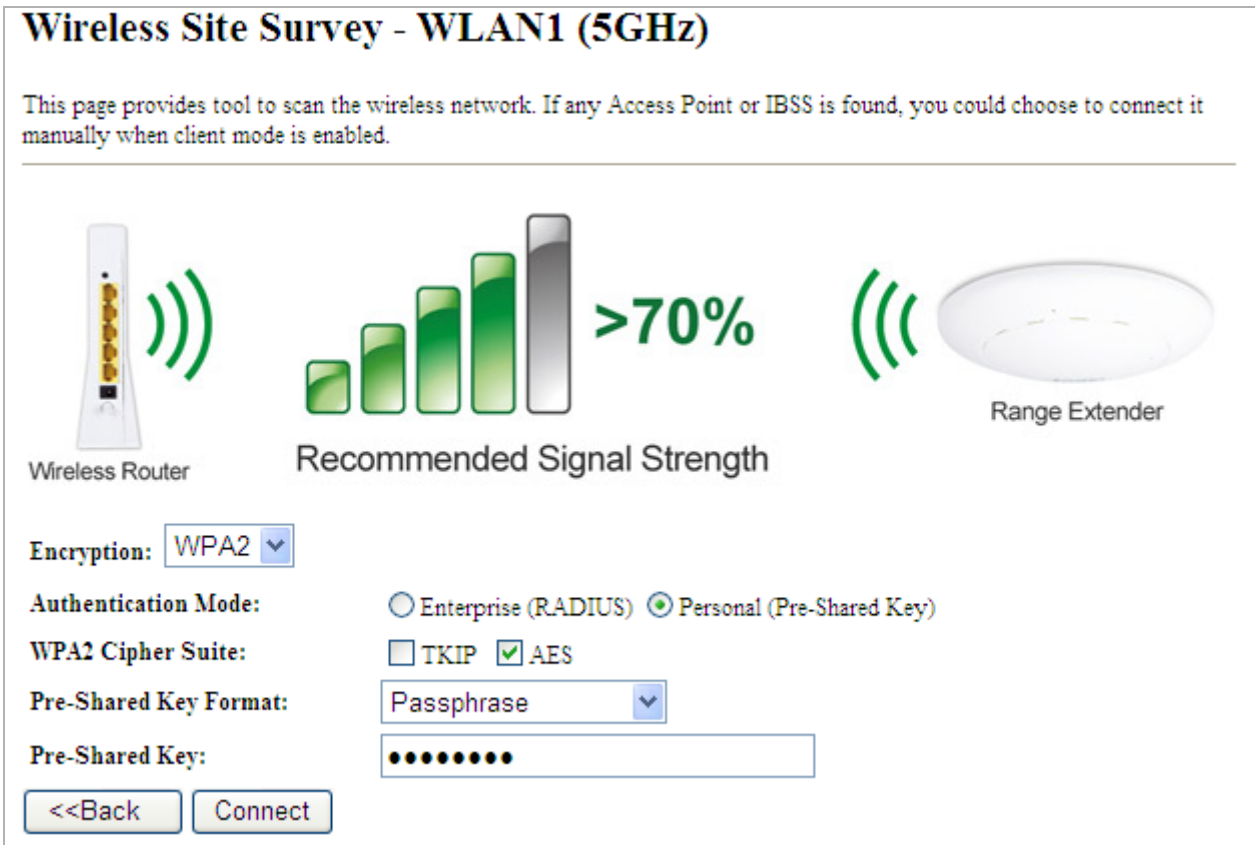


Figure 5-24 5GHz Universal Repeater-3

**Step 4.** Check “Add to Wireless Profile” and click “Reboot Now”.



Figure 5-25 5GHz Universal Repeater-4

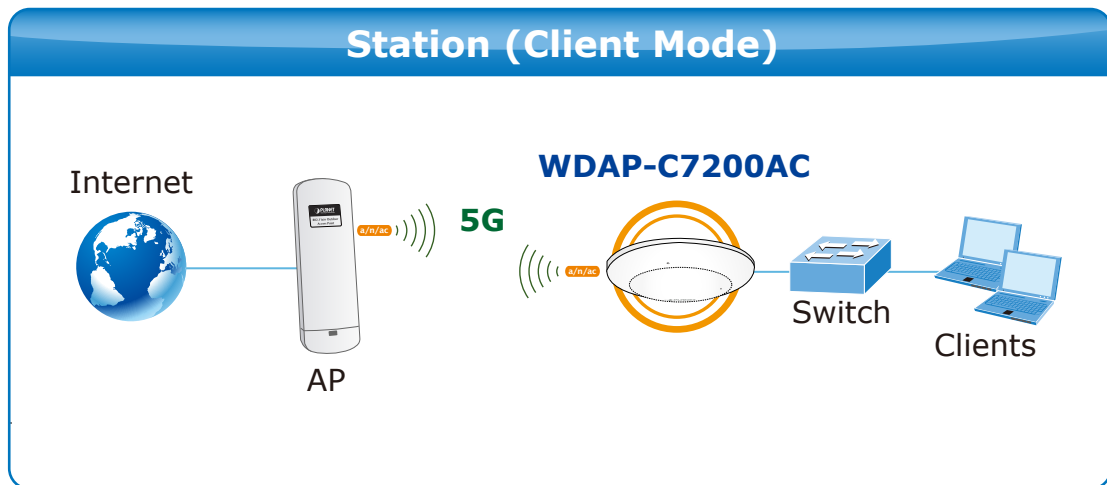
**Step 5.** Go to “Management-> Status” page to check whether the state of Repeater interface should be “Connected”.

Wireless 1 Repeater Interface Configuration	
Mode	Infrastructure Client
SSID	Default_5G_1
Encryption	WPA2
BSSID	00:30:4f:b4:c4:a8
State	Connected

Figure 5-26 5GHz Universal Repeater-5

■ **Client (Infrastructure)**

Combine the Wireless Router to the Ethernet devices such as TV, game player, or HDD and DVD, to make them be wireless stations.



### Wireless Basic Settings - WLAN1 (5 GHz)

Disable Wireless LAN Interface

Band: 5 GHz (A+N+AC) ▼

Mode: Client ▼ MultipleAP

Network Type: Infrastructure ▼

SSID: Planet AP 5G Add to Profile

Channel Width: 40MHz ▼

Control Sideband: Auto ▼

Channel Number: 36 ▼

Broadcast SSID: Enabled ▼

WMM: Enabled ▼

Data Rate: Auto ▼

TX restrict: 0 Mbps (0:no restrict)

RX restrict: 0 Mbps (0:no restrict)

Associated Clients: Show Active Clients

Enable Mac Clone (Single Ethernet Client)

SSID of Extended Add to Profile

Interface: Planet Rpt0

Enable Wireless Profile

Wireless Profile List:

SSID	Encrypt	Select
<span>Delete Selected</span> <span>DeleteAll</span>		

Figure 5-27 5GHz Wireless Basic Settings – Client

The page includes the following fields:

Object	Description
<b>Disable Wireless LAN Interface</b>	Check the box to disable the wireless function.
<b>Band</b>	<p>Select the desired mode. Default is “<b>5GHz (A+N+AC)</b>”. It is strongly recommended that you set the Band to “<b>5GHz (A+N+AC)</b>”, and all of 802.11a, 802.11n, and 802.11ac wireless stations can connect to the WDAP-C7200AC/WDAP-W7200AC.</p> <ul style="list-style-type: none"> <li>■ <b>5 GHz (A)</b>: 802.11a mode, rate is up to 54Mbps</li> <li>■ <b>5 GHz (N)</b>: 802.11n mode, rate is up to 300Mbps</li> <li>■ <b>5 GHz (AC)</b>: 802.11n mode, rate is up to 867Mbps(2T2R)</li> <li>■ <b>5 GHz (A+N)</b>: 802.11a/n mode, rate is up to 300Mbps</li> <li>■ <b>5 GHz (N+AC)</b>: 802.11n/ac mode, rate is up to 300Mbps or 867Mbps</li> <li>■ <b>5 GHz (A+N+AC)</b>: 802.11a/n/ac mode, rate is up to 54Mbps, 300Mbps, or 867Mbps</li> </ul>
<b>Mode</b>	<p>There are four kinds of wireless mode selections:</p> <ul style="list-style-type: none"> <li>■ <b>AP</b></li> <li>■ <b>Client</b></li> <li>■ <b>WDS</b></li> <li>■ <b>AP+WDS</b></li> </ul> <p>If you select WDS or AP+WDS, please click “<b>WDS Settings</b>” in the submenu for the related configuration. Furthermore, click “<b>Multiple AP</b>” to enable multiple SSID functions.</p>
<b>Network Type</b>	<p>In <b>Infrastructure</b>, the wireless LAN serves as a wireless station. And the user can use the PC equipped with the WDAP-C7200AC/WDAP-W7200AC to access the wireless network via other access points. In <b>ad hoc</b>, the wireless LAN will use the ad-hoc mode to operate.</p> <p>Default is “<b>Infrastructure</b>”.</p> <p><b>Note:</b> Only while the wireless mode is set to “<b>Client</b>”, then the <b>Network Type</b> can be configured.</p>
<b>SSID</b>	<p>It is the ID of the wireless network. User can access the wireless network via its ID. However, if you switch to Client mode, this field becomes the SSID of the AP you want to connect with.</p> <p>Default: <b>Planet AP 5G</b></p>
<b>Broadcast SSID</b>	<p>If you enable “Broadcast SSID”, every wireless station located within the coverage of the WDAP-C7200AC/WDAP-W7200AC can discover its signal easily. If you are building a public wireless network, enabling this feature is recommended. In private network, disabling “Broadcast</p>


	<p>SSID” can provide better wireless network security.</p> <p>Default is “<b>Enabled</b>”.</p>
<b>Data Rate</b>	<p>Set the wireless data transfer rate to a certain value. Since most of wireless devices will negotiate with each other and pick a proper data transfer rate automatically, <b>it’s not necessary to change this value unless you know what will happen after modification.</b></p> <p>Default is “<b>Auto</b>”.</p>
<b>Enable Mac Clone (Single Ethernet Client)</b>	<p>Enable Mac Clone.</p>

- Example of how to configure **Client Mode**. Please take the following steps:  
To configure each wireless parameter, please go to the “**WLAN1 (5GHz) → Basic Settings**” page.


**Step 1.** Go to “**WLAN1 (5GHz) → Site Survey**” page and click “**Site Survey**”.

### Wireless Site Survey - WLAN1 (5GHz)

This page provides tool to scan the wireless network. If any Access Point or IBSS is found, you could choose to connect it manually when client mode is enabled.




Wireless Router



>70%

Recommended Signal Strength



Range Extender

SSID	BSSID	Channel	Type	Encrypt	Signal
None					

**Figure 5-28** Client – Survey


**Step 2.** Choose the root AP from the list. If the root AP is not listed in the table, re-click “**Site Survey**” to update the list.




### Wireless Site Survey - WLAN1 (5GHz)

This page provides tool to scan the wireless network. If any Access Point or IBSS is found, you could choose to connect it manually when client mode is enabled.


---



Wireless Router



Recommended Signal Strength



Range Extender

Site Survey

SSID	BSSID	Channel	Type	Encrypt	Signal	Select
WDRT-1200AC-5G	00:30:4f:1c:7e:e4	149 (A+N+AC)	AP	WPA2-PSK	40	<input type="radio"/>
Default_5G_1	00:30:4f:b4:c4:a8	157 (A+N)	AP	WPA2-PSK	30	<input checked="" type="radio"/>

Next>>


Figure 5-29 Client – AP List

**Step 3.** Enter the Security Key of the root AP and then click “Connect”.


### Wireless Site Survey - WLAN1 (5GHz)

This page provides tool to scan the wireless network. If any Access Point or IBSS is found, you could choose to connect it manually when client mode is enabled.


---



Wireless Router



Recommended Signal Strength



Range Extender

Encryption: WPA2 ▼

Authentication Mode:  Enterprise (RADIUS)  Personal (Pre-Shared Key)

WPA2 Cipher Suite:  TKIP  AES

Pre-Shared Key Format: Passphrase ▼

Pre-Shared Key: ●●●●●●●●

<<Back
Connect

Figure 5-30 Client – Security



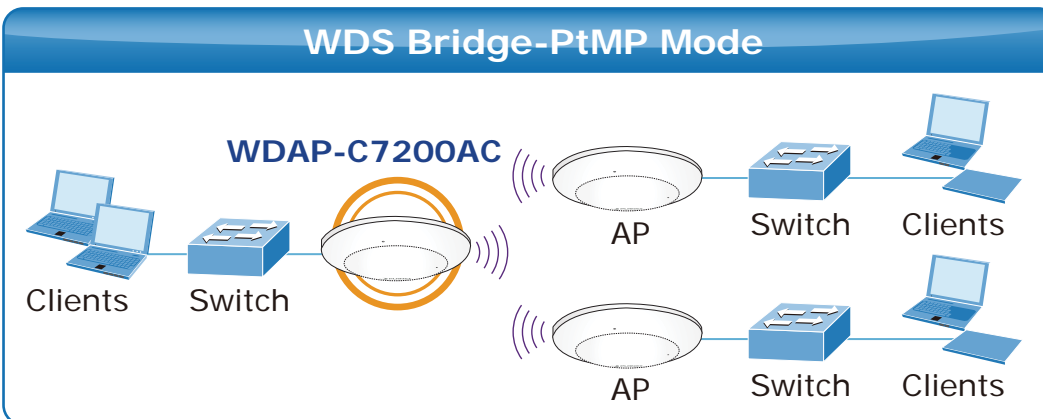
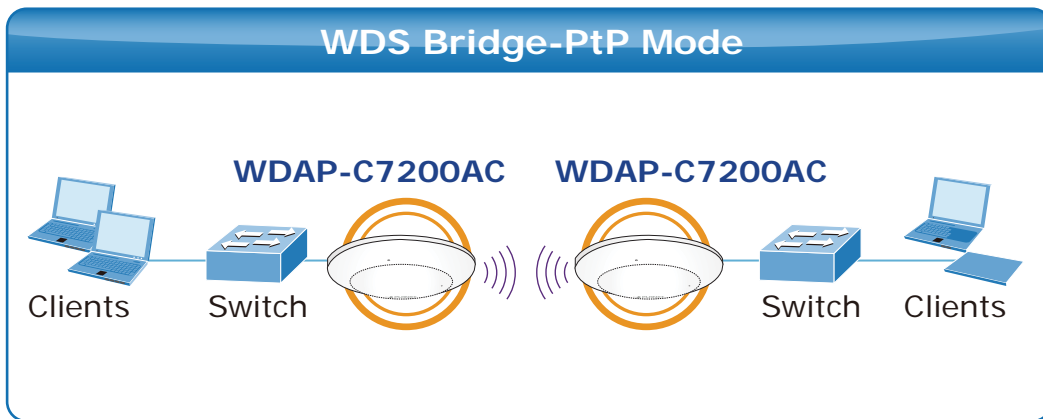
**Step 4.** Wait until the connection is established. Check the “Add to Wireless Profile” option and then reboot it.



Figure 5-31 Client – Status

■ **WDS**

Connect this Wireless AP with up to 8 WDS-capable wireless APs to expand the scope of network.



### Wireless Basic Settings - WLAN1 (5 GHz)

This page is used to configure the parameters for wireless LAN clients which may connect to your Access Point. Here you may change wireless encryption settings as well as wireless network parameters.

---

Disable Wireless LAN Interface

Band:

**Mode:**

Network Type:

SSID:

Channel Width:

Control Sideband:

Channel Number:

Broadcast SSID:

WMM:

Data Rate:

TX restrict:  Mbps (0:no restrict)

RX restrict:  Mbps (0:no restrict)

Associated Clients:

Enable Mac Clone (Single Ethernet Client)

Enable Universal Repeater Mode (Acting as AP and client simultaneously)

SSID of Extended Interface:

Figure 5-32 5GHz Wireless Basic Settings – WDS

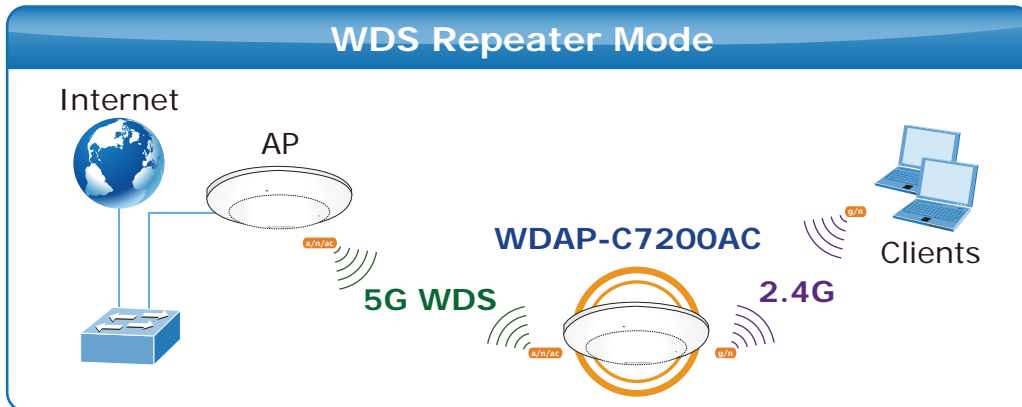
The page includes the following fields:

Object	Description
Disable Wireless LAN Interface	Check the box to disable the wireless function.
Band	Select the desired mode. Default is "5GHz (A+N+AC)". It is strongly recommended that you set the Band to "5GHz (A+N+AC)", and all of 802.11a, 802.11n, and 802.11ac wireless stations can connect to the

	<p>WDAP-C7200AC/WDAP-W7200AC.</p> <ul style="list-style-type: none"> <li>■ <b>5 GHz (A)</b>: 802.11a mode, rate is up to 54Mbps</li> <li>■ <b>5 GHz (N)</b>: 802.11n mode, rate is up to 300Mbps</li> <li>■ <b>5 GHz (AC)</b>: 802.11n mode, rate is up to 867Mbps(2T2R)</li> <li>■ <b>5 GHz (A+N)</b>: 802.11a/n mode, rate is up to 300Mbps</li> <li>■ <b>5 GHz (N+AC)</b>: 802.11n/ac mode, rate is up to 300Mbps or 867Mbps</li> <li>■ <b>5 GHz (A+N+AC)</b>: 802.11a/n/ac mode, rate is up to 54Mbps, 300Mbps, or 867Mbps</li> </ul>
<b>Mode</b>	<p>There are four kinds of wireless mode selections:</p> <ul style="list-style-type: none"> <li>■ <b>AP</b></li> <li>■ <b>Client</b></li> <li>■ <b>WDS</b></li> <li>■ <b>AP+WDS</b></li> </ul> <p>If you select WDS or AP+WDS, please click “<b>WDS Settings</b>” in the submenu for the related configuration. Furthermore, click “<b>Multiple AP</b>” to enable multiple SSID functions.</p>
<b>Channel Width</b>	You can select <b>20MHz</b> , <b>40MHz</b> or <b>80MHz</b> .
<b>Control Sideband</b>	You can select <b>Upper</b> or <b>Lower</b> .
<b>Channel Number</b>	You can select the operating frequency of wireless network.
<b>Data Rate</b>	<p>Set the wireless data transfer rate to a certain value. Since most of wireless devices will negotiate with each other and pick a proper data transfer rate automatically, <b>it's not necessary to change this value unless you know what will happen after modification.</b></p> <p>Default is “<b>Auto</b>”.</p>

■ **AP+WDS**

Connect this wireless AP with up to 8 WDS-capable wireless APs, and connect another AP to provide service for all wireless stations within its coverage.



### Wireless Basic Settings - WLAN1 (5 GHz)

Disable Wireless LAN Interface

Band: 5 GHz (A+N+AC) ▾

Mode: AP+WDS ▾ MultipleAP

Network Type: Infrastructure ▾

SSID: Planet AP 5G Add to Profile

Channel Width: 80MHz ▾

Control Sideband: Auto ▾

Channel Number: 149 ▾

Broadcast SSID: Enabled ▾

WMM: Enabled ▾

Data Rate: Auto ▾

TX restrict: 0 Mbps (0:no restrict)

RX restrict: 0 Mbps (0:no restrict)

Associated Clients: Show Active Clients

Enable Mac Clone (Single Ethernet Client)

Enable Universal Repeater Mode (Acting as AP and client simultaneously)

SSID of Extended

Interface: Planet Rpt0 Add to Profile

Apply Changes Reset

Figure 5-33 5GHz Wireless Basic Settings – WDS+AP

The page includes the following fields:

Object	Description
<b>Disable Wireless LAN Interface</b>	Check the box to disable the wireless function.
<b>Country</b>	Select your region from the pull-down list. This field specifies the region where the wireless function of the Router can be used. It may be illegal to use the wireless function of the Router in a region other than one of those specified in this field. If your country or region is not listed, please contact your local government agency for assistance.
<b>Band</b>	<p>Select the desired mode. Default is <b>“5GHz (A+N+AC)”</b>. It is strongly recommended that you set the band to <b>“5GHz (A+N+AC)”</b>, and all of 802.11a, 802.11n, and 802.11ac wireless stations can connect to the WDAP-C7200AC/WDAP-W7200AC.</p> <ul style="list-style-type: none"> <li>■ <b>5 GHz (A)</b>: 802.11a mode, rate is up to 54Mbps</li> <li>■ <b>5 GHz (N)</b>: 802.11n mode, rate is up to 300Mbps</li> <li>■ <b>5 GHz (AC)</b>: 802.11n mode, rate is up to 867Mbps(2T2R)</li> <li>■ <b>5 GHz (A+N)</b>: 802.11a/n mode, rate is up to 300Mbps</li> <li>■ <b>5 GHz (N+AC)</b>: 802.11n/ac mode, rate is up to 300Mbps or 867Mbps</li> <li>■ <b>5 GHz (A+N+AC)</b>: 802.11a/n/ac mode, rate is up to 54Mbps, 300Mbps, or 867Mbps</li> </ul>
<b>Mode</b>	<p>There are four kinds of wireless mode selections:</p> <ul style="list-style-type: none"> <li>■ <b>AP</b></li> <li>■ <b>Client</b></li> <li>■ <b>WDS</b></li> <li>■ <b>AP+WDS</b></li> </ul> <p>If you select WDS or AP+WDS, please click <b>“WDS Settings”</b> submenu for the related configuration. Furthermore, click <b>“Multiple APs”</b> to enable multiple SSID functions.</p>
<b>SSID</b>	<p>It's the ID of the wireless network. User can access the wireless network via its ID only. However, if you switch to Client Mode, this field becomes the SSID of the AP you want to connect with.</p> <p>Default: <b>Planet AP 5G</b></p>
<b>Channel Width</b>	You can select <b>20MHz, 40MHz or 80MHz</b> .
<b>Control Sideband</b>	You can select <b>Upper or Lower</b> .
<b>Channel Number</b>	You can select the operating frequency of wireless network.
<b>Broadcast SSID</b>	If you enable <b>“Broadcast SSID”</b> , every wireless station located within the coverage of the WDAP-C7200AC/WDAP-W7200AC can discover its signal easily. If you are building a public wireless network, enabling this feature is recommended. In private network, disabling <b>“Broadcast</b>

	<p>SSID” can provide better wireless network security.</p> <p>Default is “<b>Enabled</b>”.</p>
<b>Data Rate</b>	<p>Set the wireless data transfer rate to a certain value. Since most of wireless devices will negotiate with each other and pick a proper data transfer rate automatically, <b>it’s not necessary to change this value unless you know what will happen after modification.</b></p> <p>Default is “<b>Auto</b>”.</p>
<b>Associated Clients</b>	<p>Click “<b>Show Active Clients</b>” to show the status table of active wireless clients.</p>
<b>Enable Universal Repeater Mode</b> <b>(Acting as AP and client simultaneously)</b>	<p>Universal Repeater is a technology used to extend wireless coverage. To enable Universal Repeater mode, check the box and enter the SSID you want to broadcast in the field below. Then please click “Security” in the submenu for the related settings of the AP you want to connect with.</p>

### 5.4.2 Advanced Settings

Choose menu “**WLAN1 (5GHz)→ Advanced Settings**” and you can configure the 5GHz advanced settings for the wireless network on this page. After the configuration, please click “**Apply**” to save the settings.

### Wireless Advanced Settings - WLAN1 (5GHz)

These settings are only for more technically advanced users who have a sufficient knowledge about wireless LAN. These settings should not be changed unless you know what effect the changes will have on your Access Point.

---

**Fragment Threshold:**  (256-2346)

**RTS Threshold:**  (0-2347)

**Beacon Interval:**  (20-1024 ms)

**IAPP:**  Enabled  Disabled

**Protection:**  Enabled  Disabled

**Aggregation:**  Enabled  Disabled

**Short GI:**  Enabled  Disabled

**WLAN Partition:**  Enabled  Disabled

**STBC:**  Enabled  Disabled

**LDPC:**  Enabled  Disabled

**Figure 5-34** Wireless Advanced Settings – 5GHz

The page includes the following fields:

Object	Description
<b>Fragment Threshold</b>	You can specify the maximum size of packet during the fragmentation of data to be transmitted. If you set this value too low, it will result in bad performance. Default is "2346".
<b>RTS Threshold</b>	When the packet size is smaller than the RTS threshold, the access point will not use the RTS/CTS mechanism to send this packet. Default is "2347".
<b>Beacon Interval</b>	The interval of time that this access point broadcasts a beacon. Beacon is used to synchronize the wireless network. Default is "100".
<b>IAPP</b>	<b>IAPP (Inter-Access Point Protocol)</b> enabled is recommended as it describes an optional extension to IEEE 802.11 that provides wireless access-point communications among multi-vendor systems. Default is "Enabled".
<b>Protection</b>	It is recommended to enable the protection mechanism. This mechanism can decrease the rate of data collision between 802.11b and 802.11g wireless stations. When the protection mode is enabled, the throughput of the AP will be a little lower due to the transmission of heavy frame traffic. Default is "Disabled".
<b>Aggregation</b>	It is a function where the values of multiple rows are grouped together. Default is "Enabled"
<b>Short GI</b>	It is used to set the time that the receiver waits for RF reflections to settle out before sampling data. Default is "Enabled"
<b>WLAN Partition</b>	This feature is also called " <b>WLAN isolation</b> " or " <b>Block Relay</b> ". If this is enabled, wireless clients cannot exchange data through the WDAP-C7200AC/WDAP-W7200AC. Default is "Disabled".
<b>STBC</b>	Activate <b>Space Time Blocking Code (STBC)</b> which does not need channel state information (CSI). Default Setting: "Enabled"
<b>LDPC</b>	Low-density Parity-check Code is wireless data transmit algorithm. Default Setting: "Enabled"

### 5.4.3 RF Output Power

Choose menu “**WLAN1 (5GHz) → RF Output Power**” to adjust to different levels of transmitting power for the wireless network according to various environments on this page. After the configuration, please click “**Apply Changes**” to save the settings.

## Wireless RF Output Power - WLAN1 (5GHz)

RF Output Power Control provides the flexibility to control the WiFi Transmit power to optimize the wireless range. Wifi power consumption for a Access Point could be reduced to up to 75% from its peak power consumption for serving a small to medium size home, while boosted to maximum power for a large homes and businesses. The WDAP-C7200AC supports output power control levels up to 5. You can change the RF output power level here depends on the various environments and signal strength.

RF Output Power:    100%    70%    50%    35%    15%

**Figure 5-35** RF Output Power – 5GHz

RF Output Power Control provides the flexibility to control the Wi-Fi transmit power to optimize the wireless range. Wi-Fi power consumption for an Access Point could be reduced to up to 75% from its peak power consumption for serving small to medium size homes, while maximum power is boosted for large homes and businesses. The WDAP-C7200AC/WDAP-W7200AC supports output power control levels up to 5. You can change the RF output power level here in accordance with various environments and signal strength.



### 5.4.4 Security

Choose menu “**WLAN1 (5GHz) → Security**” and you can configure the settings of wireless security for the wireless network on this page. After the configuration, please click “**Apply Changes**” to save the settings.



Figure 5-36 Wireless Security Settings – 5GHz

The page includes the following fields:

Object	Description
Select SSID	Select the SSID you want to configure the wireless security function, which includes the root one and the client one.
Encryption	<ul style="list-style-type: none"> <li>■ <b>Disable:</b> No security setup for wireless connection.</li> <li>■ <b>WEP:</b> It is based on the IEEE 802.11 standard. And the default setting of authentication is <b>Automatic</b>, which can select <b>Open System</b> or <b>Shared Key</b> authentication type automatically based on the wireless station's capability and request. Furthermore, you can select <b>Key Length</b> and enter 10 and 26 <b>Hexadecimal</b> digits (any combination of 0-9, a-f, A-F, zero key is not promoted) or 5 and 13 <b>ASCII</b> characters in the <b>Encryption Key</b> field.</li> <li>■ <b>WPA:</b> WPA is a medium level encryption and is supported by most wireless devices and operating systems.</li> </ul>

	<ul style="list-style-type: none"> <li>■ <b>WPA2:</b> WPA2 is a high level encryption and is supported by most wireless devices and operating systems.</li> </ul>
	<ul style="list-style-type: none"> <li>■ <b>WPA / WPA2 / WPA-Mixed:</b> WPA Mixed Mode allows the use of both WPA and WPA2 at the same time.</li> </ul>
<b>Authentication Mode</b>	<ul style="list-style-type: none"> <li>■ <b>Enterprise (RADIUS)</b> When you select the authentication mode based on Enterprise (Radius Server), please enter the <b>IP Address</b>, <b>Port</b>, and <b>Password</b> of the Radius Server.</li> </ul>
	<ul style="list-style-type: none"> <li>■ <b>Personal (Pre-shared Key)</b> When you select the other authentication mode based on Personal (Pre-shared Key), please enter at least 8 ASCII characters (Passphrase) or 64 Hexadecimal characters. All of the Cipher Suites support <b>TKIP</b> and <b>AES</b>.</li> </ul>
<b>802.1x Authentication</b>	Enable 802.1x authentication function and then please enter the <b>IP Address</b> , <b>Port</b> , and <b>Password</b> of the Radius Server.

### 5.4.5 Access Control

Choose menu “**WLAN1 (5GHz) → Access Control**” to allow or deny the computer of specified MAC address to connect with the WDAP-C7200AC/WDAP-W7200AC on this page. After the configuration, please click “**Apply Changes**” to save the settings.

### Wireless Access Control - WLAN1 (5GHz)

If you choose 'Allowed Listed', only those clients whose wireless MAC addresses are in the access control list will be able to connect to your Access Point. When 'Deny Listed' is selected, these wireless clients on the list will not be able to connect the Access Point.

---

Wireless Access Control Mode: Disable ▼

MAC Address:  Allow Listed

Deny Listed

**Current Access Control List:**

MAC Address	Comment	Select

**Figure 5-37** Wireless Access Control – 5GHz

The page includes the following fields:

Object	Description
--------	-------------

<b>Wireless Access Control Mode</b>	You can choose to set the Allowed-List, Denied-List, or disable this function.
<b>MAC Address</b>	Enter the MAC address you want to allow or deny connection to the WDAP-C7200AC/WDAP-W7200AC in the field.
<b>Comment</b>	You can make some comment on each MAC address on the list.
<b>Current Access Control List</b>	You can select some MAC addresses and click “Delete Selected” to delete it.

To deny a PC at the MAC address of 00:30:4F:00:00:01 (for example) to connect to your wireless network, do as follows:

- Step 1.** Select “Deny” from MAC Address Filter drop-down menu.
- Step 2.** Enter 00:30:4F:00:00:01 in the MAC address box and click “Add”.
- Step 3.** Click “OK” to save your settings and you can add more MAC addresses, if you like, simply repeat the above steps.

### Wireless Access Control - WLAN1 (5GHz)

If you choose 'Allowed Listed', only those clients whose wireless MAC addresses are in the access control list will be able to connect to your Access Point. When 'Deny Listed' is selected, these wireless clients on the list will not be able to connect the Access Point.

---

Wireless Access Control Mode: Deny Listed ▼

MAC Address:  Comment:

Apply Changes
Reset

Current Access Control List:

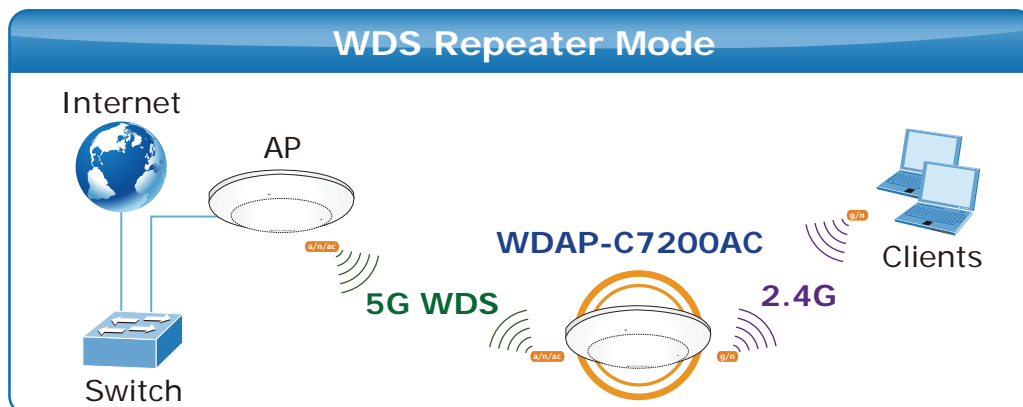
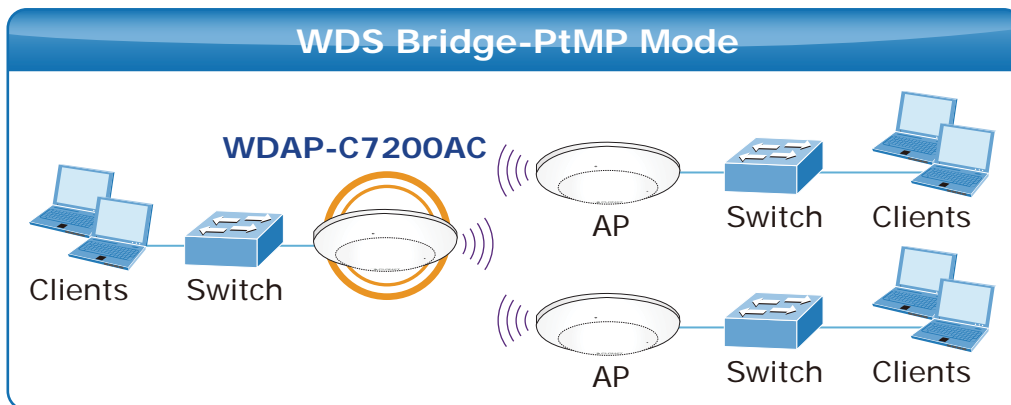
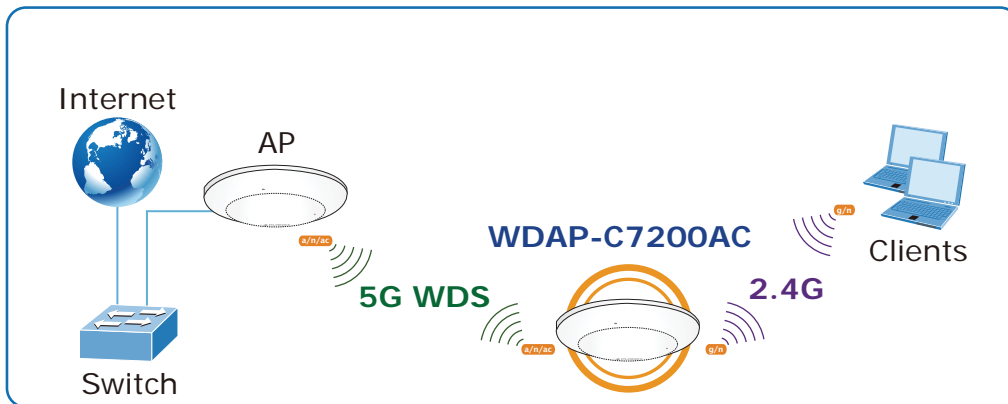
MAC Address	Comment	Select
00:30:4f:00:00:01	deny	<input type="checkbox"/>

Delete Selected
Delete All
Reset

Figure 5-38 Wireless Access Control – Deny

### 5.4.6 WDS

**WDS (Wireless Distribution System)** feature can be used to extend your existing 2.4G or 5G wireless network coverage. Here we present you how to configure such feature in 2.4GHz, which also applies to 5GHz.



Before configuring the WDS Setting page, you have to select the wireless mode to "WDS" on the **WLAN1 (5GHz)** -> **Basic Settings** web page.

### Wireless Basic Settings - WLAN1 (5 GHz)

Disable Wireless LAN Interface

Band:

Mode:

Network Type:

SSID:

Channel Width:

Figure 5-39 WDS Mode – 5GHz

Choose menu “**WLAN1 (5GHz) → WDS Settings**” to configure WDS to connect the WDAP-C7200AC/WDAP-W7200AC with another AP on this page. After the configuration, please click “**Apply Changes**” to save the settings.

### WDS Settings - WLAN1 (5GHz)

Wireless Distribution System uses wireless media to communicate with other APs, like the Ethernet does. To do this, you must set these APs in the same channel and set MAC address of other APs which you want to communicate with in the table and then enable the WDS.

Enable WDS

MAC Address:

Data Rate:

Comment:

**Current WDS AP List:**

MAC Address	Tx Rate (Mbps)	Comment	Select
00:30:4f:11:11:11	Auto	peer-1	<input type="checkbox"/>
00:30:4f:22:22:22	Auto	peer-2	<input type="checkbox"/>
00:30:4f:33:33:33	Auto	peer-3	<input type="checkbox"/>
00:30:4f:44:44:44	Auto	peer-4	<input type="checkbox"/>
00:30:4f:55:55:55	Auto	peer-5	<input type="checkbox"/>
00:30:4f:66:66:66	Auto	peer-6	<input type="checkbox"/>
00:30:4f:77:77:77	Auto	peer-7	<input type="checkbox"/>
00:30:4f:88:88:88	Auto	peer-8	<input type="checkbox"/>

Figure 5-40 WDS Settings – 5GHz

### WDS Security Setup -wlan1

This page allows you setup the wireless security for WDS. When enabled, you must make sure each WDS device has adopted the same encryption algorithm and Key.

---

Encryption:

WEP Key Format:

WEP Key:

Pre-Shared Key Format:

Pre-Shared Key:

**Figure 5-41** WDS – Set Security

The page includes the following fields:

Object	Description
<b>Enable WDS</b>	Check the box to enable the WDS function. Please select <b>WDS</b> or <b>AP+WDS</b> in the Mode of <b>Wireless Basic Settings</b> before you enable WDS on this page.
<b>MAC Address</b>	You can enter the MAC address of the AP you want to connect with.
<b>Data Rate</b>	Default is “ <b>Auto</b> ”.
<b>Comment</b>	You can make some comment for each MAC address on the list.
<b>Set Security</b>	Click “ <b>Set Security</b> ” to configure the wireless security parameters of the AP you want to connect via WDS.
<b>Show Statics</b>	Click “ <b>Show Statics</b> ” to show the WDS AP.
<b>Current WDS AP List</b>	You can select some MAC addresses of the AP and click “ <b>Delete Selected</b> ” to delete it.



WDS feature can only be implemented between 2 wireless devices that both support the WDS feature. Plus, **channel**, **security settings** and **security key** must be **the same** on both such devices.



To encrypt your wireless network, click “**Set Security**”. For the detail of wireless security, see [section 5.3.3](#). Do remember to reboot the device after you save your wireless security settings; otherwise, the WDS feature may not function.


### 5.4.7 Site Survey

Choose menu “**WLAN1 (5GHz) → Site Survey**” to scan the available local AP. If any Access Point is found, you could choose any one to connect with manually when the **Client Mode** is enabled.


## Wireless Site Survey - WLAN1 (5GHz)

This page provides tool to scan the wireless network. If any Access Point or IBSS is found, you could choose to connect it manually when client mode is enabled.


---



Wireless Router



Recommended Signal Strength



Range Extender

Site Survey

SSID	BSSID	Channel	Type	Encrypt	Signal	Select
WDRT-1200AC-5G	00:30:4f:26:60:80	149 (A+N+AC)	AP	WPA2-PSK	67	<input type="radio"/>
WDRT-1200AC-5G	00:30:4f:1c:7e:e4	149 (A+N+AC)	AP	WPA2-PSK	40	<input type="radio"/>
Default_5G_1	00:30:4f:b4:c4:a8	157 (A+N)	AP	WPA2-PSK	30	<input checked="" type="radio"/>

Next>>

Figure 5-42 Site Survey – 5GHz

### 5.4.8 WPS

**WPS (Wi-Fi Protected Setup)** is designed to ease setup of security Wi-Fi networks and subsequently network management. This Wireless Router supports WPS features for **AP mode**, **AP+WDS mode**, **Infrastructure-Client mode**, and the wireless root interface of **Universal Repeater mode**.

Simply enter a Pin code or press the software PBC button or hardware WPS button (if any) and a secure wireless connection is established.

- **PBC:** If you find the WPS LED blinking for 2 minutes after you press the hardware WPS button on the device, it means that PBC encryption method is successfully enabled. And an authentication will be performed between your router and the WPS/PBC-enabled wireless client device during this time; if it succeeds, the wireless client device connects to your device, and the WPS LED turns off. Repeat steps mentioned above if you want to connect more wireless client devices to the device.



- **PIN** : To use this option, you must know the Pin code from the wireless client and enter it in corresponding field on your device while using the same Pin code on client side for such connection.

The page includes the following fields:

Object	Description
<b>Disable WPS</b>	You can check the box to disable the WPS function.
<b>WPS Status</b>	Here you can check if the connection via WPS is established or not.
<b>Self-Pin Number</b>	It is the Pin number of the WDAP-C7200AC/WDAP-W7200AC here.
<b>Push Button Configuration</b>	Click " <b>Start PBC</b> " to activate WPS as well in the client device within 2 minutes.
<b>Client Pin Number</b>	In addition to the PBC method, you can also use the Pin method to activate the WPS. Just enter the Pin number of the client device in the field and click " <b>Start Pin</b> ".



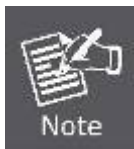
The WPS encryption can be implemented only between your Router and another WPS-capable device.

- Example of how to establish wireless connection using **WPS**. Please take the following steps:

**Step 1.** Choose menu "**WLAN1 (5GHz) → WPS**" to configure the setting for WPS. After the configuration, please click "**Apply Changes**" to save the settings.

**Step 2.** Add a new device.

If the wireless adapter supports Wi-Fi Protected Setup (WPS), you can establish a wireless connection between wireless adapter and AP using either Push Button Configuration (PBC) method or Pin method.

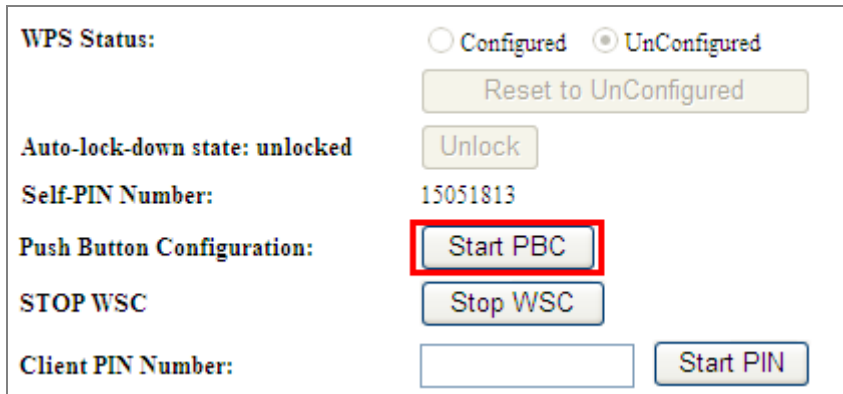


To build a successful connection by WPS, you should also do the corresponding configuration of the new device for WPS function.

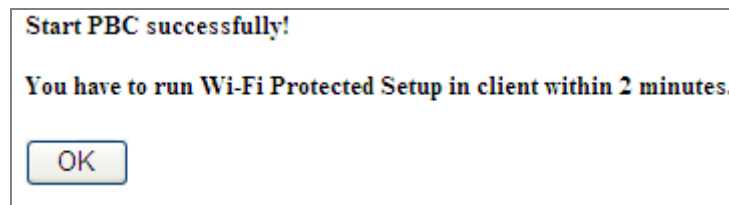
#### A. By Push Button Configuration (PBC)



- i. Click “**Start PBC**” on the WPS page of the AP.



**Figure 5-43** WPS-PBC – 5GHz-1



**Figure 5-44** WPS-PBC – 5GHz-2

- ii. Press and hold the WPS button equipped on the adapter directly for 2 or 3 seconds. Or you can click the WPS button with the same function in the configuration utility of the adapter. The process must be finished within 2 minutes.
- iii. Wait for a while until the next screen appears. Click **OK** to complete the WPS configuration.

## B. By Pin

If the new device supports Wi-Fi Protected Setup and the Pin method, you can add it to the network by Pin with the following two methods.

**Method One:** Enter the Pin of your wireless adapter into the configuration utility of the AP

- i. Enter the Pin code of the wireless adapter in the field behind **Client Pin Number** in the following figure. Then click **Start Pin**.



The Pin code of the adapter is always displayed on the WPS configuration screen.

WPS Status:  Configured  UnConfigured  
 Reset to UnConfigured

Auto-lock-down state: unlocked

Self-PIN Number: 15051813

Push Button Configuration:

STOP WSC

Client PIN Number:

Figure 5-45 WPS-PIN – 5GHz-1

Applied WPS PIN successfully!  
 You have to run Wi-Fi Protected Setup within 2 minutes.

Figure 5-46 WPS-PIN – 5GHz-2

- ii. For the configuration of the wireless adapter, please choose the option that you want to **enter Pin into the AP (Enrollee)** in the configuration utility of the WPS and click **Next** until the process finishes.

**Method Two:** Enter the Pin of the AP into the configuration utility of your wireless adapter

- i. Click **“Start PBC”** on the WPS page of the AP. Get the current Pin code of the AP on [WPS page](#) (each AP has its unique Pin code).

WPS Status:  Configured  UnConfigured  
 Reset to UnConfigured

Auto-lock-down state: unlocked

**Self-PIN Number: 15051813** Enter this PIN into the wireless adapter's configuration page.

Push Button Configuration:

STOP WSC

Client PIN Number:

Figure 5-47 WPS-PIN – 5GHz-3

- ii. For the configuration of the wireless adapter, please choose the option that you want to **enter the Pin of the AP (Registrar)** in the configuration utility of the wireless adapter and enter it into the field. Then click **Next** until the process finishes.

### 5.4.9 Schedule

Wireless Schedules will enable or disable your wireless access at a set time based on your predefined schedule. This feature is often used for restricting access to all users (such as children, employees and guests) during specific times of the day for parental control or security reasons.

Choose menu “**WLAN1 (5GHz) → Schedule**” to configure the schedule rule of enabling wireless function. After the configuration, please click “**Apply Changes**” to save the settings.

## Wireless Schedule - WLAN1 (5GHz)

This page allows you setup the wireless schedule rule. Please do not forget to configure system time before enable this feature.

**Enable Wireless Schedule**

**Wireless Scheduled Disable**

Internet

**Wireless in Use**

Schedulable Wireless ON/OFF Control

Enable	Day	From		To			
<input type="checkbox"/>	Sun	00	(hour) 00	(min)	00	(hour) 00	(min)
<input type="checkbox"/>	Sun	00	(hour) 00	(min)	00	(hour) 00	(min)
<input type="checkbox"/>	Sun	00	(hour) 00	(min)	00	(hour) 00	(min)
<input type="checkbox"/>	Sun	00	(hour) 00	(min)	00	(hour) 00	(min)
<input type="checkbox"/>	Sun	00	(hour) 00	(min)	00	(hour) 00	(min)
<input type="checkbox"/>	Sun	00	(hour) 00	(min)	00	(hour) 00	(min)
<input type="checkbox"/>	Sun	00	(hour) 00	(min)	00	(hour) 00	(min)
<input type="checkbox"/>	Sun	00	(hour) 00	(min)	00	(hour) 00	(min)
<input type="checkbox"/>	Sun	00	(hour) 00	(min)	00	(hour) 00	(min)
<input type="checkbox"/>	Sun	00	(hour) 00	(min)	00	(hour) 00	(min)
<input type="checkbox"/>	Sun	00	(hour) 00	(min)	00	(hour) 00	(min)

Figure 5-48 Schedule - 5GHz



When setting the Wireless Schedule, it is important to ensure that your **System Clock** settings have been configured. If not, your Wireless Schedule will not function correctly.

## 5.5 WLAN2 (2.4GHz)

The Wireless menu contains submenus of the settings about wireless network. Please refer to the following sections for the details.



Figure 5-49 2.4GHz Wireless Main Menu

### 5.5.1 Basic Settings

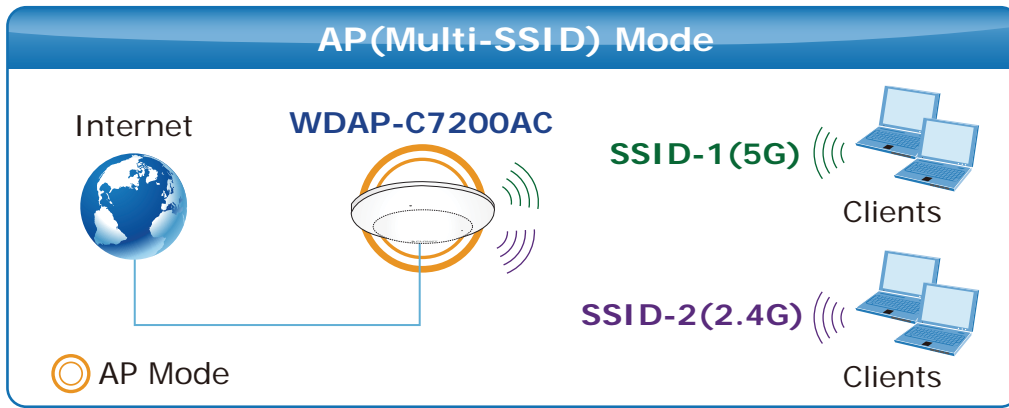
Choose menu “**WLAN2 (2.4GHz) → Basic Settings**” to configure the 2.4GHz basic settings for the wireless network on this page. After the configuration is done, please click “**Apply Changes**” to save the settings.

First of all, the wireless AP supports multiple wireless modes for different network applications, which include:

- **AP**
- **Multiple SSIDs**
- **Universal Repeater**
- **Client**
- **WDS**
- **AP+WDS**

It is so easy to combine the WDAP-C7200AC/WDAP-W7200AC with the existing wired network. The WDAP-C7200AC/WDAP-W7200AC definitely provides a total network solution for the home and the SOHO users.

- **AP**  
Standard **Access Point**



### Wireless Basic Settings - WLAN2 (2.4GHz)

Disable Wireless LAN Interface

Band:

Mode:

Network Type:

SSID:

Channel Width:

Control Sideband:

Channel Number:

Broadcast SSID:

WMM:

Data Rate:

TX restrict:  Mbps (0:no restrict)

RX restrict:  Mbps (0:no restrict)

Associated Clients:

Enable Mac Clone (Single Ethernet Client)

Enable Universal Repeater Mode (Acting as AP and client simultaneously)

SSID of Extended

Interface:

Figure 5-50 2.4GHz Wireless Basic Settings – AP

The page includes the following fields:

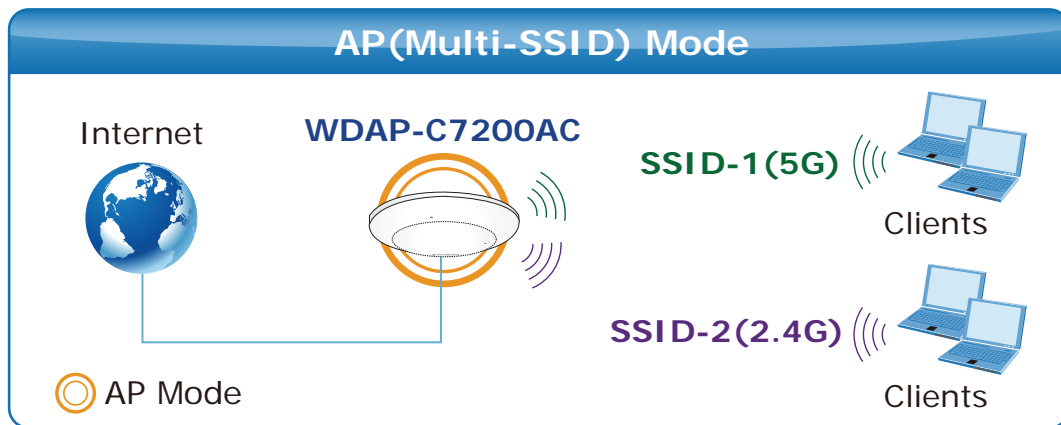
Object	Description
Disable Wireless LAN Interface	Check the box to disable the wireless function.

<p><b>Band</b></p>	<p>Select the desired mode. Default is “<b>2.4GHz (B+G+N)</b>”. It is strongly recommended that you set the Band to “2.4GHz (B+G+N)”, and all of 802.11b, 802.11g, and 802.11n wireless stations can connect to the WDAP-C7200AC/WDAP-W7200AC.</p> <ul style="list-style-type: none"> <li>■ <b>2.4 GHz (B)</b>: 802.11b mode, rate is up to 11Mbps</li> <li>■ <b>2.4 GHz (G)</b>: 802.11g mode, rate is up to 54Mbps</li> <li>■ <b>2.4 GHz (N)</b>: 802.11n mode, rate is up to 300Mbps(2T2R)</li> <li>■ <b>2.4 GHz (B+G)</b>: 802.11b/g mode, rate is up to 11Mbps or 54Mbps</li> <li>■ <b>2.4 GHz (G+N)</b>: 802.11g/n mode, rate is up to 54Mbps or 300Mbps</li> <li>■ <b>2.4 GHz (B+G+N)</b>: 802.11b/g/n mode, rate is up to 11Mbps, 54Mbps, or 300Mbps</li> </ul>
<p><b>Mode</b></p>	<p>There are four kinds of wireless mode selections:</p> <ul style="list-style-type: none"> <li>■ <b>AP</b></li> <li>■ <b>Client</b></li> <li>■ <b>WDS</b></li> <li>■ <b>AP+WDS</b></li> </ul> <p>If you select WDS or AP+WDS, please click “<b>WDS Settings</b>” in the submenu for the related configuration. Furthermore, click “<b>Multiple AP</b>” to enable multiple SSID functions.</p>
<p><b>SSID</b></p>	<p>It’s the ID of the wireless network. User can access the wireless network via the ID only. However, if you switch to Client Mode, this field becomes the SSID of the AP you want to connect with.</p> <p>Default: <b>Planet AP 2.4G</b></p>
<p><b>Channel Width</b></p>	<p>You can select <b>20MHz</b>, or <b>40MHz</b>.</p>
<p><b>Channel Number</b></p>	<p>You can select the operating frequency of wireless network.</p> <p>Default: <b>11</b></p>
<p><b>Broadcast SSID</b></p>	<p>If you enable “Broadcast SSID”, every wireless station located within the coverage of the AP can discover its signal easily. If you are building a public wireless network, enabling this feature is recommended. In private network, disabling “Broadcast SSID” can provide better wireless network security.</p> <p>Default is “<b>Enabled</b>”.</p>
<p><b>Data Rate</b></p>	<p>Set the wireless data transfer rate to a certain value. Since most of wireless devices will negotiate with each other and pick a proper data transfer rate automatically, <b>it’s not necessary to change this value unless you know what will happen after modification.</b></p> <p>Default is “<b>Auto</b>”.</p>
<p><b>Associated Clients</b></p>	<p>Click “<b>Show Active Clients</b>” to show the status table of active wireless clients.</p>

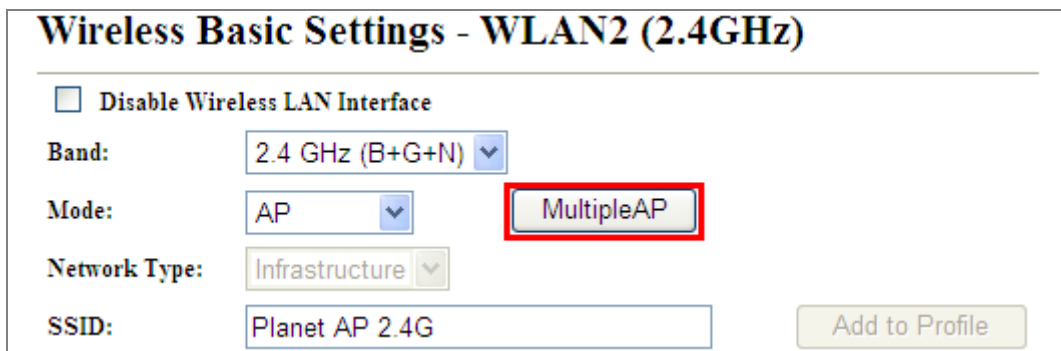
<p><b>Enable Universal Repeater Mode</b>  (Acting as AP and client simultaneously)</p>	<p>Universal Repeater is a technology used to extend wireless coverage. To enable Universal Repeater mode, check the box and enter the SSID you want to broadcast in the field below. Then please click <b>“Security”</b> in the submenu for the related settings of the AP you want to connect with.</p>
--	---

■ **Multiple-SSID**

Enabling multiple-SSID can broadcast multiple WLAN SSIDs using virtual interfaces. You can have different encryption settings for each WLAN and you can restrict what they have access to.



Choose menu **“WLAN1 (2.4GHz) → Basic Settings → Multiple AP”** to configure the device as a general wireless access point with multiple SSIDs.



**Figure 5-51** 2.4GHz Wireless Basic Settings – Multiple APs

The device supports up to four multiple Service Set Identifiers. You can go back to the **Basic Settings** page to set the Primary SSID. The SSID's factory default setting is **Planet 2.4G VAP1~4 (Multiple-SSID 1~4)**. The SSID can be easily changed to connect to an existing wireless network or to establish a new wireless network. When the information for the new SSID is finished, click **Apply Changes** to let your changes take effect.



### Multiple APs Multiple APs - WLAN2 (2.4GHz)

This page shows and updates the wireless setting for multiple APs.

No.	Enable	Band	SSID	Data Rate	Broadcast SSID	WMM	Access	Tx Restrict (Mbps)	Rx Restrict (Mbps)	Active Client List	WLAN mode
AP1	<input checked="" type="checkbox"/>	2.4 GHz (B+G+N)	Planet 2.4G VA	Auto	Enabled	Enabled	LAN	0	0	Show	AP
AP2	<input checked="" type="checkbox"/>	2.4 GHz (B+G+N)	Planet 2.4G VA	Auto	Enabled	Enabled	LAN	0	0	Show	AP
AP3	<input checked="" type="checkbox"/>	2.4 GHz (B+G+N)	Planet 2.4G VA	Auto	Enabled	Enabled	LAN	0	0	Show	AP
AP4	<input checked="" type="checkbox"/>	2.4 GHz (B+G+N)	Planet 2.4G VA	Auto	Enabled	Enabled	LAN	0	0	Show	AP

Apply Changes

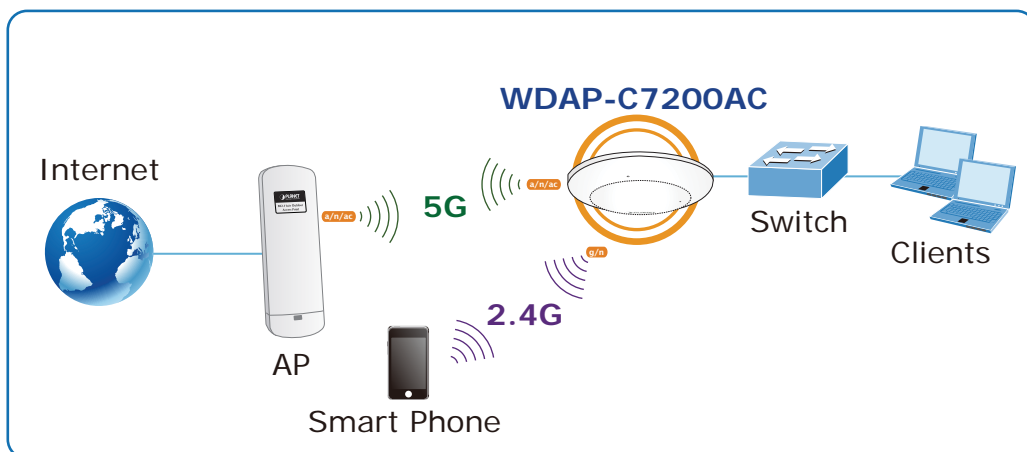
Reset

Figure 5-52 2.4GHz Multiple-SSID

Once you have applied and saved those settings, you can then go to the “**WLAN1 (2.4GHz) → Security**” page on the AP to set up security settings for each of the SSIDs.

#### ■ Universal Repeater

This mode allows the AP with its own BSS to relay data to a root AP to which it is associated with WDS disabled. The wireless repeater relays signal between its stations and the root AP for greater wireless range.



- Example of how to configure **Universal Repeater Mode**. Please take the following steps:  
To configure each wireless parameter, please go to the “**WLAN2 (2.4GHz) → Basic Settings**” page.

**Step 1.** Configure wireless mode to “**AP**” and then check “**Enable Universal Repeater Mode (Acting as AP and client simultaneously)**”. Click “**Apply Changes**” to take effect.



### Wireless Basic Settings - WLAN2 (2.4GHz)

This page is used to configure the parameters for wireless LAN clients which may connect to your Access Point. Here you may change wireless encryption settings as well as wireless network parameters.

Disable Wireless LAN Interface

Band:

Mode:

Network Type:

SSID:

Enable Mac Clone (Single Ethernet Client)


Enable Universal Repeater Mode (Acting as AP and client simultaneously)

SSID of Extended

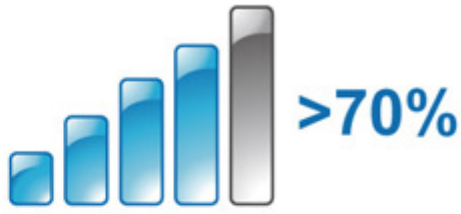
Figure 5-53 2.4GHz Universal Repeater-1

**Step 2.** Go to **2.4GHz Site Survey** page to find the root AP. Select the root AP that you want to repeat the signal, and then click **“Next”**.


### Wireless Site Survey - WLAN2 (2.4GHz)



Wireless Router



Recommended Signal Strength



Range Extender

SSID	BSSID	Channel	Type	Encrypt	Signal	Select
WDRT-1200AC-5G	00:30:4f:74:20:08	6 (B+G+N)	AP	WPA2-PSK	78	<input type="radio"/>
WiFiRepeater-001	00:30:4f:91:1c:44	1 (B+G+N)	AP	no	60	<input type="radio"/>
Default_2.4G_1	00:30:4f:b4:c4:a0	11 (B+G+N)	AP	WPA2-PSK	52	<input checked="" type="radio"/>
WDRT-1200AC-2.4G	00:30:4f:1c:7e:e4	6 (B+G+N)	AP	WPA2-PSK	44	<input type="radio"/>

Figure 5-54 2.4GHz Universal Repeater-2

**Step 3.** Select the correct encryption method and enter the security key. Then, click “Connect”.

### Wireless Site Survey - WLAN2 (2.4GHz)

This page provides tool to scan the wireless network. If any Access Point or IBSS is found, you could choose to connect it manually when client mode is enabled.

**Wireless Router**      **Recommended Signal Strength >70%**      **Range Extender**

Encryption: **WPA2** ▾

Authentication Mode:  Enterprise (RADIUS)  Personal (Pre-Shared Key)

WPA2 Cipher Suite:  TKIP  AES

Pre-Shared Key Format: **Passphrase** ▾

Pre-Shared Key: ●●●●●●●●

**<<Back**      **Connect**

**Figure 5-55** 2.4GHz Universal Repeater-3

**Step 4.** Check “Add to Wireless Profile” and click “Reboot Now”.

**Connect successfully!**

Add to Wireless Profile

**Reboot Now**      **Reboot Later**

**Figure 5-56** 2.4GHz Universal Repeater-4

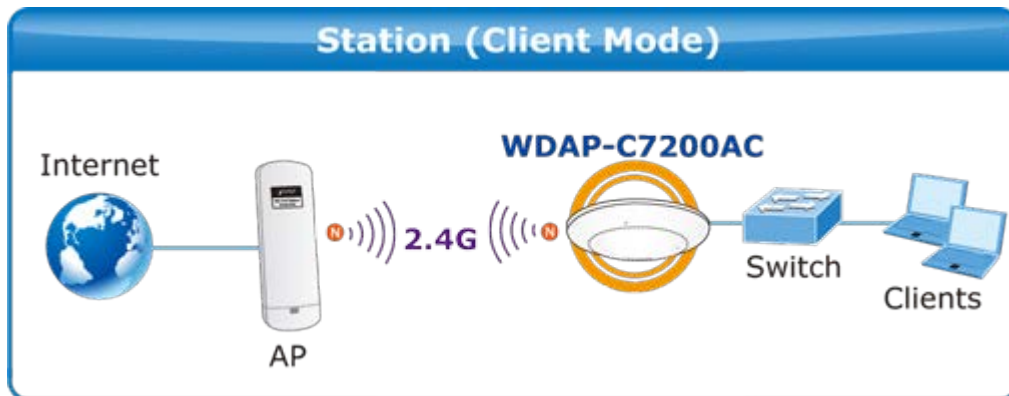
**Step 5.** Go to the “Management-> Status” page to check whether the state of Repeater interface should be “Connected”.

Wireless 2 Repeater Interface Configuration	
Mode	Infrastructure Client
SSID	Default_2.4G_1
Encryption	WPA2
BSSID	00:30:4f:b4:c4:a0
State	Connected

**Figure 5-57** 2.4GHz Universal Repeater-5

■ **Client (Infrastructure)**

Combine the Wireless Router to the Ethernet devices such as TV, Game player, or HDD and DVD, to make them be wireless stations.



### Wireless Basic Settings - WLAN2 (2.4GHz)

Disable Wireless LAN Interface

Band: 2.4 GHz (B+G+N) ▼

Mode: Client ▼ MultipleAP

Network Type: Infrastructure ▼

SSID: Planet AP 2.4G Add to Profile

Channel Width: 40MHz ▼

Control Sideband: Upper ▼

Channel Number: 11 ▼

Broadcast SSID: Enabled ▼

WMM: Enabled ▼

Data Rate: Auto ▼

TX restrict: 0 Mbps (0:no restrict)

RX restrict: 0 Mbps (0:no restrict)

Associated Clients: Show Active Clients

Enable Mac Clone (Single Ethernet Client)

SSID of Extended Interface: Default\_2.4G\_1 Add to Profile

Enable Wireless Profile

Wireless Profile List:

SSID	Encrypt	Select

Delete Selected DeleteAll

Figure 5-58 2.4GHz Wireless Basic Settings – Client

The page includes the following fields:

Object	Description
<b>Disable Wireless LAN Interface</b>	Check the box to disable the wireless function.
<b>Band</b>	<p>Select the desired mode. Default is “<b>2.4GHz (B+G+N)</b>”. It is strongly recommended that you set the Band to “2.4GHz (B+G+N)”, and all of 802.11b, 802.11g, and 802.11n wireless stations can connect to the WDAP-C7200AC/WDAP-W7200AC.</p> <ul style="list-style-type: none"> <li>■ <b>2.4 GHz (B)</b>: 802.11b mode, rate is up to 11Mbps</li> <li>■ <b>2.4 GHz (G)</b>: 802.11g mode, rate is up to 54Mbps</li> <li>■ <b>2.4 GHz (N)</b>: 802.11n mode, rate is up to 300Mbps(2T2R)</li> <li>■ <b>2.4 GHz (B+G)</b>: 802.11b/g mode, rate is up to 11Mbps or 54Mbps</li> <li>■ <b>2.4 GHz (G+N)</b>: 802.11g/n mode, rate is up to 54Mbps or 300Mbps</li> <li>■ <b>2.4 GHz (B+G+N)</b>: 802.11b/g/n mode, rate is up to 11Mbps, 54Mbps, or 300Mbps</li> </ul>
<b>Mode</b>	<p>There are four kinds of wireless mode selections:</p> <ul style="list-style-type: none"> <li>■ <b>AP</b></li> <li>■ <b>Client</b></li> <li>■ <b>WDS</b></li> <li>■ <b>AP+WDS</b></li> </ul> <p>If you select WDS or AP+WDS, please click “<b>WDS Settings</b>” in the submenu for the related configuration. Furthermore, click “<b>Multiple AP</b>” to enable multiple SSID functions.</p>
<b>Network Type</b>	<p>In <b>Infrastructure</b>, the wireless LAN serves as a wireless station. And the user can use the PC equipped with the WDAP-C7200AC/WDAP-W7200AC to access the wireless network via other access points. In <b>ad hoc</b>, the wireless LAN will use the ad-hoc mode to operate.</p> <p>Default is “<b>Infrastructure</b>”.</p> <p><b>Note: only while the wireless mode is set to “Client”, then the Network Type can be configured.</b></p>
<b>SSID</b>	<p>It’s the ID of the wireless network. User can access the wireless network via the ID only. However, if you switch to Client Mode, this field becomes the SSID of the AP you want to connect with.</p> <p>Default: <b>Planet AP 2.4G</b></p>
<b>Broadcast SSID</b>	<p>If you enable “Broadcast SSID”, every wireless station located within the coverage of the WDAP-C7200AC/WDAP-W7200AC can discover its signal easily. If you are building a public wireless network, enabling this feature is recommended. In private network, disabling “Broadcast</p>


	SSID” can provide better wireless network security. Default is “ <b>Enabled</b> ”.
<b>Data Rate</b>	Set the wireless data transfer rate to a certain value. Since most of wireless devices will negotiate with each other and pick a proper data transfer rate automatically, <b>it’s not necessary to change this value unless you know what will happen after modification.</b> Default is “ <b>Auto</b> ”.
<b>Enable Mac Clone (Single Ethernet Client)</b>	Enable Mac Clone.

- Example of how to configure **Client Mode**. Please take the following steps:  
To configure each wireless parameter, please go to the “**WLAN2 (2.4GHz)** → **Basic Settings**” page.


**Step 1.** Go to the “**WLAN2 (2.4GHz)** → **Site Survey**” page and click “**Site Survey**”.

### Wireless Site Survey - WLAN2 (2.4GHz)


This page provides tool to scan the wireless network. If any Access Point or IBSS is found, you could choose to connect it manually when client mode is enabled.



Wireless Router



Recommended Signal Strength



Range Extender


SSID	BSSID	Channel	Type	Encrypt	Signal	Select
None						

**Figure 5-59** Client – Survey

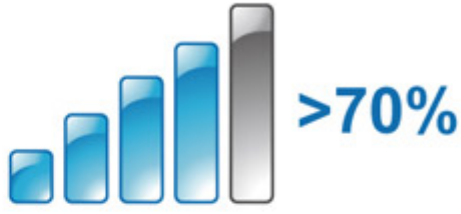
**Step 2.** Choose the root AP from the list. If the root AP is not listed in the table, re-click “Site Survey” to update the list.

### Wireless Site Survey - WLAN2 (2.4GHz)

This page provides tool to scan the wireless network. If any Access Point or IBSS is found, you could choose to connect it manually when client mode is enabled.




Wireless Router



>70%

Recommended Signal Strength



Range Extender

SSID	BSSID	Channel	Type	Encrypt	Signal	Select
WDRT-1200AC-5G	00:30:4f:74:20:08	6 (B+G+N)	AP	WPA2-PSK	78	<input type="radio"/>
WDRT-1200AC-5G	00:30:4f:76:20:08	6 (B+G+N)	AP	WPA2-PSK	78	<input type="radio"/>
WiFiRepeater-001	00:30:4f:91:1c:44	1 (B+G+N)	AP	no	60	<input type="radio"/>
Default_2.4G_1	00:30:4f:b4:c4:a0	11 (B+G+N)	AP	WPA2-PSK	52	<input checked="" type="radio"/>
WDRT-1200AC-2.4G	00:30:4f:1c:7e:e4	6 (B+G+N)	AP	WPA2-PSK	44	<input type="radio"/>
ADN-4100_ENM	00:30:4f:9c:a3:25	1 (B+G+N)	AP	WPA-PSK/WPA2-PSK	44	<input type="radio"/>
PLANET_11F_AP	00:30:4f:81:ed:88	11 (B+G+N)	AP	WPA2-PSK	29	<input type="radio"/>

**Figure 5-60** Client – AP List

**Step 3.** Enter the Security Key of the root AP and then click “Connect”.

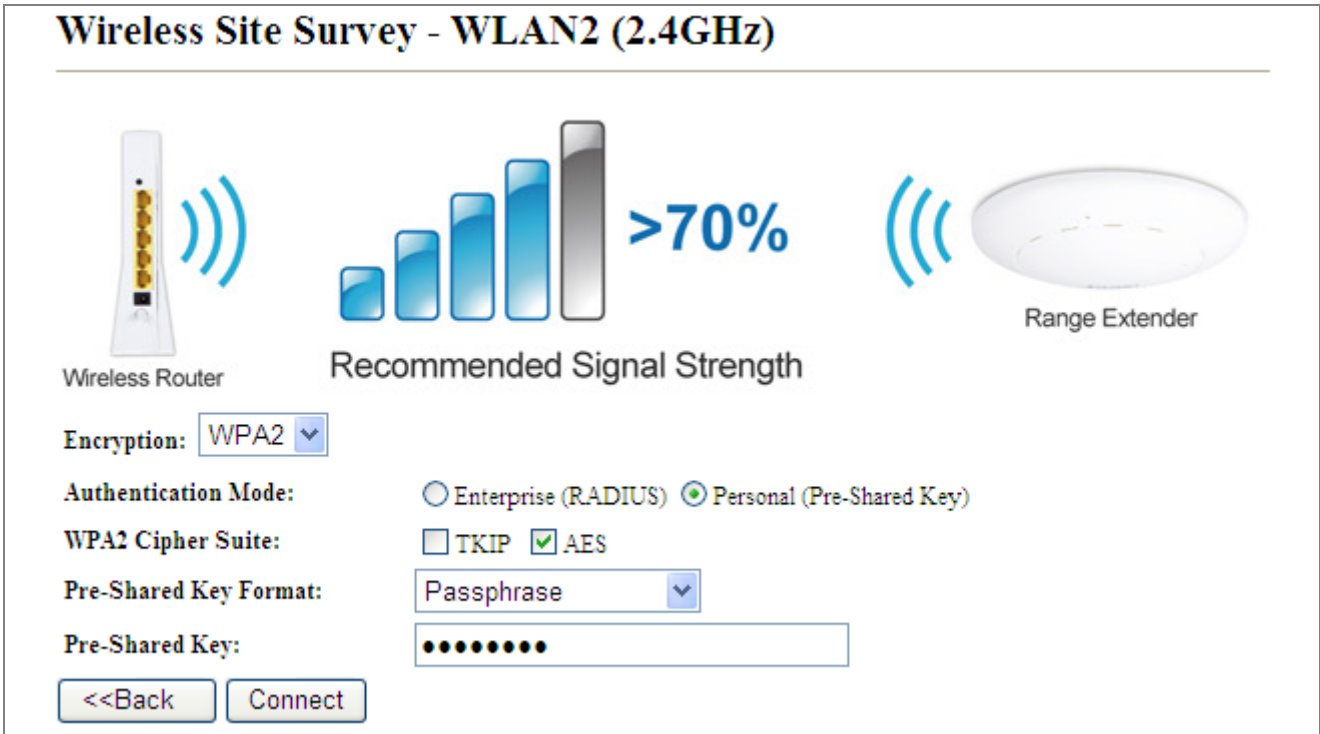


Figure 5-61 Client – Security

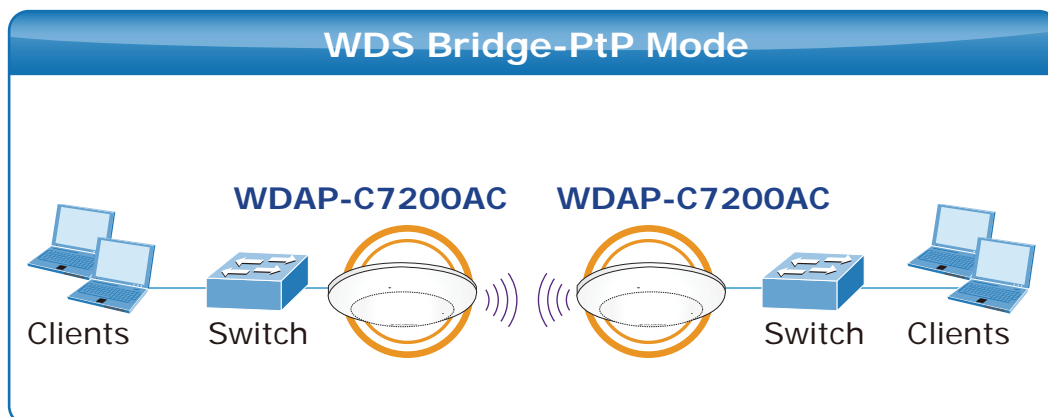
**Step 4.** Wait until the connection is established. Check the “Add to Wireless Profile” option and then reboot it.



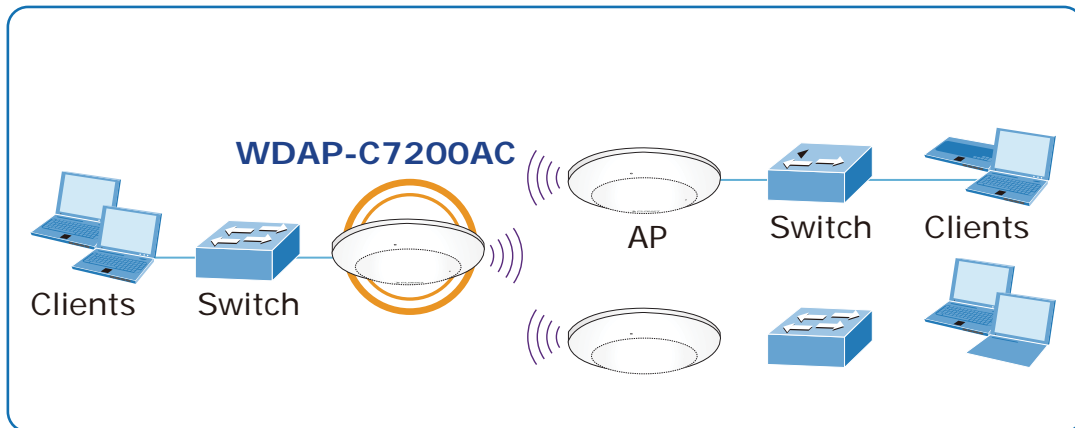
Figure 5-62 Client – Status

■ **WDS**

Connect this Wireless AP with up to 8 WDS-capable wireless APs to expand the scope of network.







## Wireless Basic Settings - WLAN2 (2.4GHz)

This page is used to configure the parameters for wireless LAN clients which may connect to your Access Point. Here you may change wireless encryption settings as well as wireless network parameters.

Disable Wireless LAN Interface

Band: 2.4 GHz (B+G+N) ▼

Mode: WDS ▼

MultipleAP

Network Type: Infrastructure ▼

SSID: Planet AP 2.4G

Add to Profile

Channel Width: 40MHz ▼

Control Sideband: Upper ▼

Channel Number: 11 ▼

Broadcast SSID: Enabled ▼

WMM: Enabled ▼

Data Rate: Auto ▼

TX restrict: 0 Mbps (0:no restrict)

RX restrict: 0 Mbps (0:no restrict)

Associated Clients: Show Active Clients

Enable Mac Clone (Single Ethernet Client)

Enable Universal Repeater Mode (Acting as AP and client simultaneously)

SSID of Extended

Interface: Default\_2.4G\_1

Add to Profile

Apply Changes

Reset

Figure 5-63 2.4GHz Wireless Basic Settings – WDS

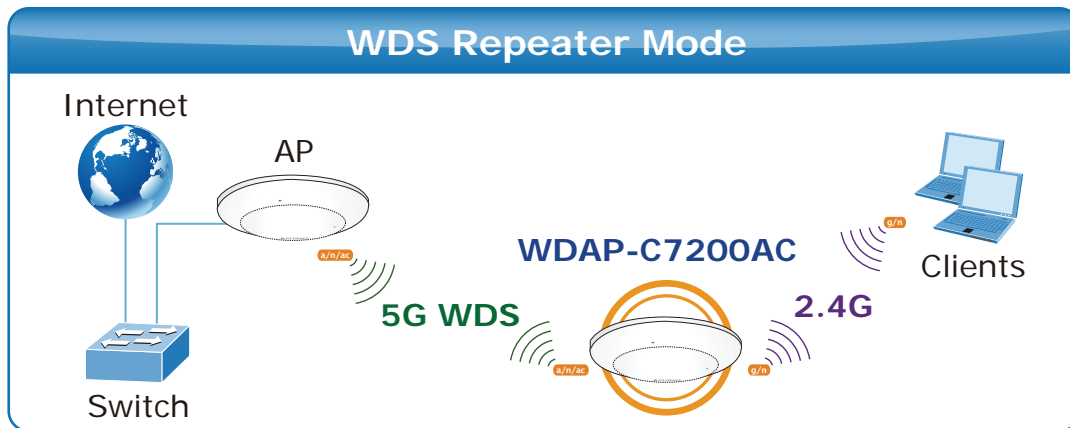


The page includes the following fields:

Object	Description
<b>Disable Wireless LAN Interface</b>	Check the box to disable the wireless function.
<b>Band</b>	<p>Select the desired mode. Default is “<b>2.4GHz (B+G+N)</b>”. It is strongly recommended that you set the Band to “2.4GHz (B+G+N)”, and all of 802.11b, 802.11g, and 802.11n wireless stations can connect to the WDAP-C7200AC/WDAP-W7200AC.</p> <ul style="list-style-type: none"> <li>■ <b>2.4 GHz (B)</b>: 802.11b mode, rate is up to 11Mbps</li> <li>■ <b>2.4 GHz (G)</b>: 802.11g mode, rate is up to 54Mbps</li> <li>■ <b>2.4 GHz (N)</b>: 802.11n mode, rate is up to 300Mbps(2T2R)</li> <li>■ <b>2.4 GHz (B+G)</b>: 802.11b/g mode, rate is up to 11Mbps or 54Mbps</li> <li>■ <b>2.4 GHz (G+N)</b>: 802.11g/n mode, rate is up to 54Mbps or 300Mbps</li> <li>■ <b>2.4 GHz (B+G+N)</b>: 802.11b/g/n mode, rate is up to 11Mbps, 54Mbps, or 300Mbps</li> </ul>
<b>Mode</b>	<p>There are four kinds of wireless mode selections:</p> <ul style="list-style-type: none"> <li>■ <b>AP</b></li> <li>■ <b>Client</b></li> <li>■ <b>WDS</b></li> <li>■ <b>AP+WDS</b></li> </ul> <p>If you select WDS or AP+WDS, please click “<b>WDS Settings</b>” in the submenu for the related configuration. Furthermore, click “<b>Multiple AP</b>” to enable multiple SSID function.</p>
<b>Channel Width</b>	You can select <b>20MHz</b> , or <b>40MHz</b>
<b>Control Sideband</b>	You can select <b>Upper</b> or <b>Lower</b> .
<b>Channel Number</b>	You can select the operating frequency of wireless network.
<b>Data Rate</b>	<p>Set the wireless data transfer rate to a certain value. Since most of wireless devices will negotiate with each other and pick a proper data transfer rate automatically, <b>it's not necessary to change this value unless you know what will happen after modification.</b></p> <p>Default is “<b>Auto</b>”.</p>

■ **AP+ WDS**

Connect this Wireless AP with up to 8 WDS-capable wireless APs, and connect another AP to provide service for all wireless stations within its coverage.



### Wireless Basic Settings - WLAN2 (2.4GHz)

This page is used to configure the parameters for wireless LAN clients which may connect to your Access Point. Here you may change wireless encryption settings as well as wireless network parameters.

Disable Wireless LAN Interface

Band: 2.4 GHz (B+G+N) ▼

Mode: AP+WDS ▼

MultipleAP

Network Type: Infrastructure ▼

SSID: Planet AP 2.4G

Add to Profile

Channel Width: 40MHz ▼

Control Sideband: Upper ▼

Channel Number: 11 ▼

Broadcast SSID: Enabled ▼

WMM: Enabled ▼

Data Rate: Auto ▼

TX restrict: 0 Mbps (0:no restrict)

RX restrict: 0 Mbps (0:no restrict)

Associated Clients: Show Active Clients

Enable Mac Clone (Single Ethernet Client)

Enable Universal Repeater Mode (Acting as AP and client simultaneously)

SSID of Extended

Interface: Default\_2.4G\_1

Add to Profile

Apply Changes

Reset

Figure 5-64 2.4GHz Wireless Basic Settings – WDS+AP

The page includes the following fields:

Object	Description
<b>Disable Wireless LAN Interface</b>	Check the box to disable the wireless function.
<b>Country</b>	Select your region from the pull-down list. This field specifies the region where the wireless function of the Router can be used. It may be illegal to use the wireless function of the Router in a region other than one of those specified in this field. If your country or region is not listed, please contact your local government agency for assistance.
<b>Band</b>	<p>Select the desired mode. Default is “<b>2.4GHz (B+G+N)</b>”. It is strongly recommended that you set the Band to “2.4GHz (B+G+N)”, and all of 802.11b, 802.11g, and 802.11n wireless stations can connect to the WDAP-C7200AC/WDAP-W7200AC.</p> <ul style="list-style-type: none"> <li>■ <b>2.4 GHz (B)</b>: 802.11b mode, rate is up to 11Mbps</li> <li>■ <b>2.4 GHz (G)</b>: 802.11g mode, rate is up to 54Mbps</li> <li>■ <b>2.4 GHz (N)</b>: 802.11n mode, rate is up to 300Mbps(2T2R)</li> <li>■ <b>2.4 GHz (B+G)</b>: 802.11b/g mode, rate is up to 11Mbps or 54Mbps</li> <li>■ <b>2.4 GHz (G+N)</b>: 802.11g/n mode, rate is up to 54Mbps or 300Mbps</li> <li>■ <b>2.4 GHz (B+G+N)</b>: 802.11b/g/n mode, rate is up to 11Mbps, 54Mbps, or 300Mbps</li> </ul>
<b>Mode</b>	<p>There are four kinds of wireless mode selections:</p> <ul style="list-style-type: none"> <li>■ <b>AP</b></li> <li>■ <b>Client</b></li> <li>■ <b>WDS</b></li> <li>■ <b>AP+WDS</b></li> </ul> <p>If you select WDS or AP+WDS, please click “<b>WDS Settings</b>” in the submenu for the related configuration. Furthermore, click “<b>Multiple AP</b>” to enable multiple SSID functions.</p>
<b>SSID</b>	<p>It’s the ID of the wireless network. User can access the wireless network via the ID only. However, if you switch to Client Mode, this field becomes the SSID of the AP you want to connect with.</p> <p>Default: <b>Planet AP 2.4G</b></p>
<b>Channel Width</b>	You can select <b>20MHz</b> , or <b>40MHz</b>
<b>Control Sideband</b>	You can select <b>Upper</b> or <b>Lower</b> .
<b>Channel Number</b>	You can select the operating frequency of wireless network.
<b>Broadcast SSID</b>	<p>If you enable “<b>Broadcast SSID</b>”, every wireless station located within the coverage of the WDAP-C7200AC/WDAP-W7200AC can discover its signal easily. If you are building a public wireless network, enabling this feature is recommended. In private network, disabling “<b>Broadcast SSID</b>” can provide better wireless network security.</p>

	Default is <b>“Enabled”</b> .
<b>Data Rate</b>	Set the wireless data transfer rate to a certain value. Since most of wireless devices will negotiate with each other and pick a proper data transfer rate automatically, <b>it’s not necessary to change this value unless you know what will happen after modification.</b>  Default is <b>“Auto”</b> .
<b>Associated Clients</b>	Click <b>“Show Active Clients”</b> to show the status table of active wireless clients.
<b>Enable Universal Repeater Mode (Acting as AP and client simultaneously)</b>	Universal Repeater is a technology used to extend wireless coverage. To enable Universal Repeater Mode, check the box and enter the SSID you want to broadcast in the field below. Then please click <b>“Security”</b> in the submenu for the related settings of the AP you want to connect with.

### 5.5.2 Advanced Settings

Choose menu **“WLAN2 (2.4GHz)→ Advanced Settings”** to configure the 2.4GHz advanced settings for the wireless network on this page. After the configuration, please click **“Apply”** to save the settings.

### Wireless Advanced Settings - WLAN2 (2.4GHz)

These settings are only for more technically advanced users who have a sufficient knowledge about wireless LAN. These settings should not be changed unless you know what effect the changes will have on your Access Point.

---

**Fragment Threshold:**  (256-2346)

**RTS Threshold:**  (0-2347)

**Beacon Interval:**  (20-1024 ms)

**Preamble Type:**  Long Preamble  Short Preamble

**IAPP:**  Enabled  Disabled

**Protection:**  Enabled  Disabled

**Aggregation:**  Enabled  Disabled

**Short GI:**  Enabled  Disabled

**WLAN Partition:**  Enabled  Disabled

**STBC:**  Enabled  Disabled

**LDPC:**  Enabled  Disabled

**20/40MHz Coexist:**  Enabled  Disabled

**Figure 5-65** Wireless Advanced Settings – 2.4GHz

The page includes the following fields:

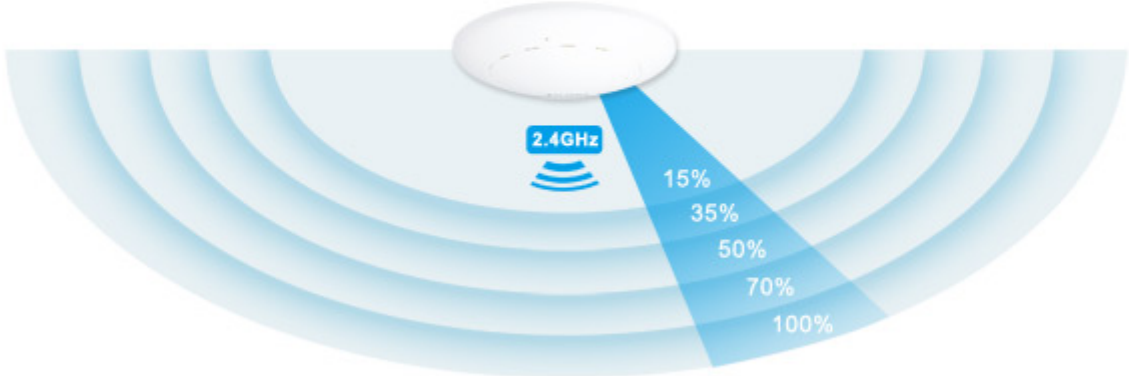
Object	Description
<b>Fragment Threshold</b>	You can specify the maximum size of packet during the fragmentation of data to be transmitted. If you set this value too low, it will result in bad performance. Default is "2346".
<b>RTS Threshold</b>	When the packet size is smaller than the RTS threshold, the access point will not use the RTS/CTS mechanism to send this packet. Default is "2347".
<b>Beacon Interval</b>	The interval of time that this access point broadcasts a beacon. Beacon is used to synchronize the wireless network. Default is "100".
<b>IAPP</b>	<b>IAPP (Inter-Access Point Protocol)</b> enabled is recommended as it describes an optional extension to IEEE 802.11 that provides wireless access-point communications among multivendor systems. Default is "Enabled".
<b>Protection</b>	It is recommended to enable the protection mechanism. This mechanism can decrease the rate of data collision between 802.11b and 802.11g wireless stations. When the protection mode is enabled, the throughput of the AP will be a little lower due to the transmission of heavy frame traffic. Default is "Disabled".
<b>Aggregation</b>	It is a function where the values of multiple rows are grouped together. Default is "Enabled"
<b>Short GI</b>	It is used to set the time that the receiver waits for RF reflections to settle out before sampling data. Default is "Enabled"
<b>WLAN Partition</b>	This feature also called " <b>WLAN isolation</b> " or " <b>Block Relay</b> ". If this is enabled, wireless clients cannot exchange data through the WDAP-C7200AC/WDAP-W7200AC. Default is "Disabled".
<b>STBC</b>	Activate <b>Space Time Blocking Code (STBC)</b> which does not need channel state information (CSI). Default Setting: "Enabled"
<b>LDPC</b>	Low-density Parity-check Code is wireless data transmit algorithm. Default Setting: "Enabled"
<b>20/40MHz Coexist</b>	Configure 20/40MHz coexisting scheme. If you set up as "Enabled", "20MHz" and "40MHz" will coexist. Default Setting: "Disabled"

### 5.5.3 RF Output Power

Choose menu “**WLAN2 (2.4GHz) → RF Output Power**” to adjust to different levels of transmitting power for the wireless network according to various environment on this page. After the configuration, please click “**Apply Changes**” to save the settings.

## Wireless RF Output Power - WLAN2 (2.4GHz)

RF Output Power Control provides the flexibility to control the WiFi Transmit power to optimize the wireless range. Wifi power consumption for a Access Point could be reduced to up to 75% from its peak power consumption for serving a small to medium size home, while boosted to maximum power for a large homes and businesses. The WDAP-C7200AC supports output power control levels up to 5. You can change the RF output power level here depends on the various environments and signal strength.



RF Output Power:

100%
  70%
  50%
  35%
  15%

Apply Changes

Reset

**Figure 5-66** RF Output Power – 2.4GHz

RF Output Power Control provides the flexibility to control the Wi-Fi Transmit power to optimize the wireless range. Wi-Fi power consumption for an Access Point could be reduced to up to 75% from its peak power consumption for serving small to medium size homes, while maximum power is boosted for large homes and businesses. The WDAP-C7200AC/WDAP-W7200AC supports output power control levels up to 5. You can change the RF output power level here in accordance with various environments and signal strength.

### 5.5.4 Security

Choose menu “**WLAN2 (2.4GHz) → Security**” to configure the settings of wireless security for the wireless network on this page. After the configuration, please click “**Apply Changes**” to save the settings.



Figure 5-67 Wireless Security Settings – 2.4GHz

The page includes the following fields:

Object	Description
Select SSID	Select the SSID you want to configure the wireless security function, which includes the root one and the client one.
Encryption	<p><b>Disable:</b> No security setup for wireless connection.</p> <ul style="list-style-type: none"> <li> <p><b>WEP:</b> It is based on the IEEE 802.11 standard. And the default setting of authentication is <b>Automatic</b>, which can select <b>Open System</b> or <b>Shared Key</b> authentication type automatically based on the wireless station's capability and request. Furthermore, you can select <b>Key Length</b> and enter 10 and 26 <b>Hexadecimal</b> digits (any combination of 0-9, a-f, A-F, zero key is not promoted) or 5 and 13 <b>ASCII</b> characters in the <b>Encryption Key</b> field.</p> </li> <li> <p><b>WPA:</b> WPA is a medium level encryption and is supported by most wireless devices and operating systems.</p> </li> </ul>



	<ul style="list-style-type: none"> <li>■ <b>WPA2:</b> WPA2 is a high level encryption and is supported by most wireless devices and operating systems.</li> </ul>
<p><b>Authentication Mode</b></p>	<ul style="list-style-type: none"> <li>■ <b>WPA / WPA2 / WPA-Mixed:</b> WPA Mixed Mode allows the use of both WPA and WPA2 at the same time.</li> </ul>
	<ul style="list-style-type: none"> <li>■ <b>Enterprise (RADIUS)</b> When you select the authentication mode based on Enterprise (RADIUS Server), please enter the <b>IP Address</b>, <b>Port</b>, and <b>Password</b> of the RADIUS Server.</li> </ul>
<p><b>802.1x Authentication</b></p>	<ul style="list-style-type: none"> <li>■ <b>Personal (Pre-shared Key)</b> When you select the other authentication mode based on Personal (Pre-shared Key), please enter at least 8 ASCII characters (Passphrase) or 64 Hexadecimal characters. All of the Cipher Suites support <b>TKIP</b> and <b>AES</b>.</li> </ul>
	<p>Enable 802.1x authentication function and then enter the <b>IP Address</b>, <b>Port</b>, and <b>Password</b> of the RADIUS Server.</p>



### 5.5.5 Access Control

Choose menu “**WLAN2 (2.4GHz) → Access Control**” to allow or deny the computer of specified MAC address to connect with the WDAP-C7200AC/WDAP-W7200AC on this page. After the configuration, please click “**Apply Changes**” to save the settings.

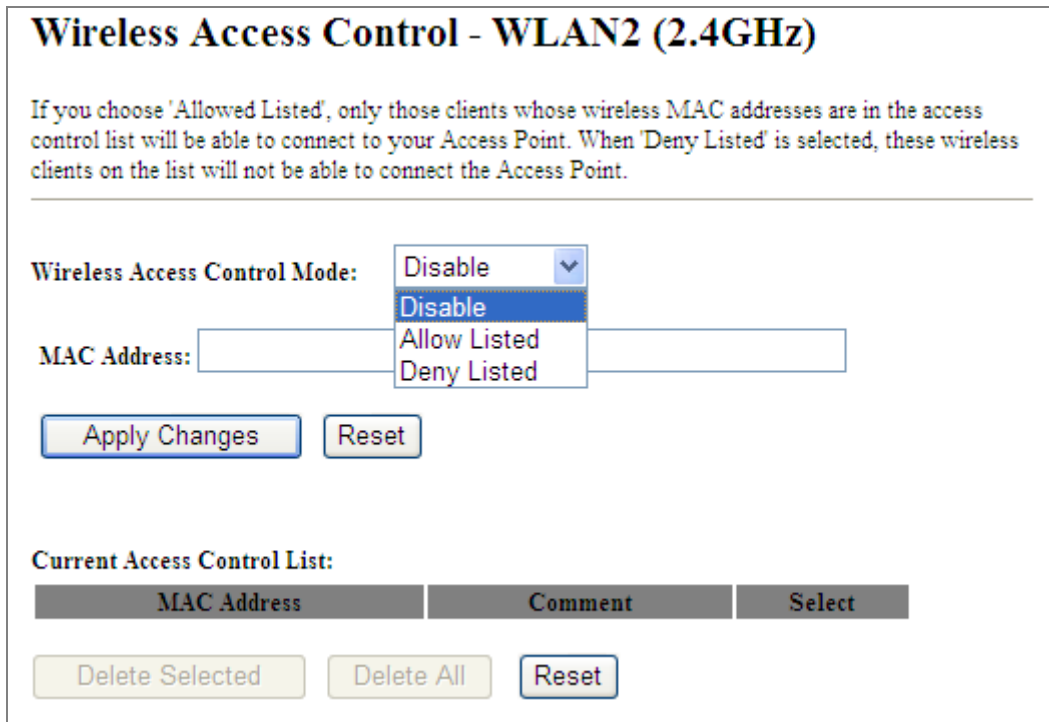


Figure 5-68 Wireless Access Control – 2.4GHz

The page includes the following fields:

Object	Description
<b>Wireless Access Control Mode</b>	You can choose to set the Allowed-List, Denied-List, or disable this function.
<b>MAC Address</b>	Enter the MAC address you want to allow or deny connection to the WDAP-C7200AC/WDAP-W7200AC in the field.
<b>Comment</b>	You can make some comment on each MAC address on the list.
<b>Current Access Control List</b>	You can select some MAC addresses and click “ <b>Delete Selected</b> ” to delete it.

■ **Wireless Access Control example:**

To deny a PC at the MAC address of 00:30:4F:00:00:01 to connect to your wireless network, do as follows:

**Step 1.** Select “**Deny**” from MAC Address Filter drop-down menu.

**Step 2.** Enter 00:30:4F:00:00:01 in the MAC address box and click “**Add**”.

**Step 3.** Click “OK” to save your settings and you can add more MAC addresses, if you like, simply repeat the above steps.

### Wireless Access Control - WLAN2 (2.4GHz)

If you choose 'Allowed Listed', only those clients whose wireless MAC addresses are in the access control list will be able to connect to your Access Point. When 'Deny Listed' is selected, these wireless clients on the list will not be able to connect the Access Point.

---

Wireless Access Control Mode:

MAC Address:  Comment:

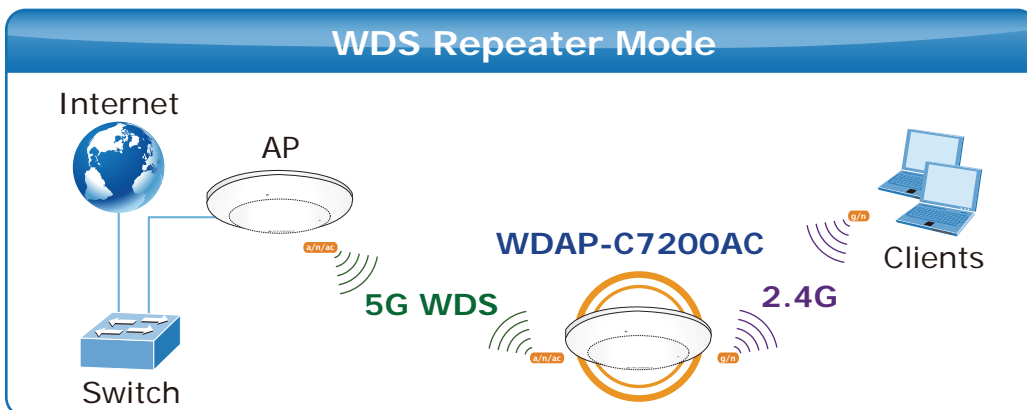
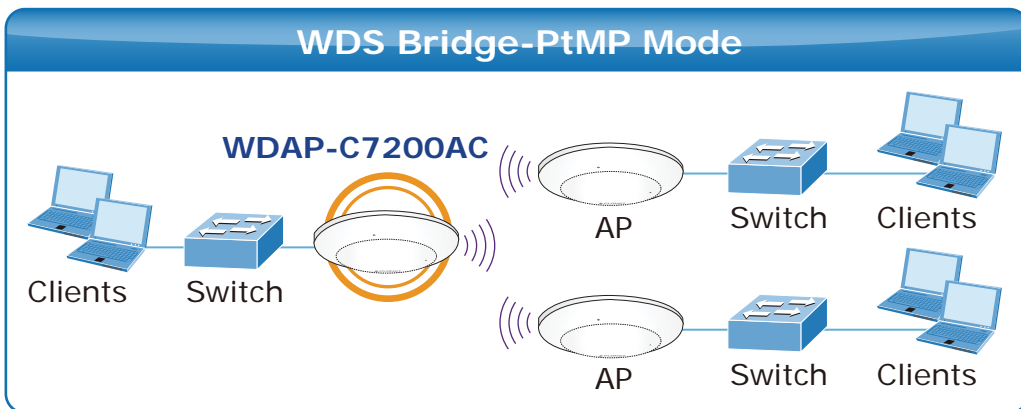
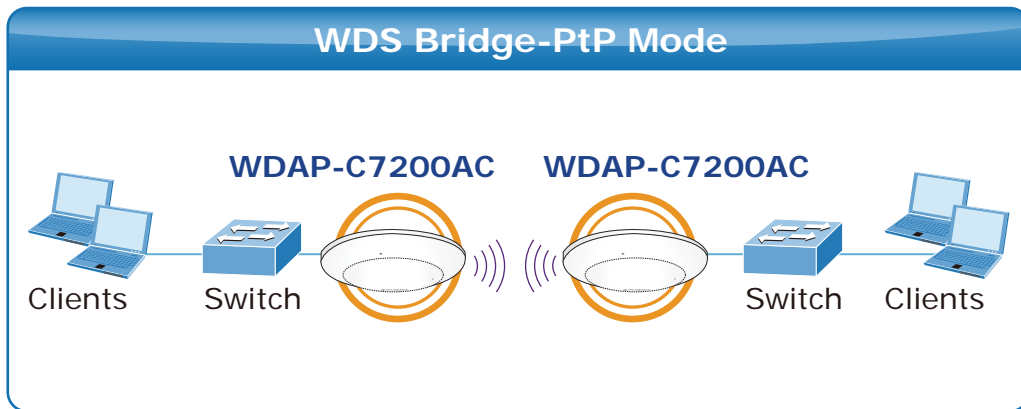
Current Access Control List:

MAC Address	Comment	Select
00:30:4f:00:00:01	deny	<input type="checkbox"/>

**Figure 5-69** Wireless Access Control – Deny

### 5.5.6 WDS

**WDS (Wireless Distribution System)** feature can be used to extend your existing 2.4G or 5G wireless network coverage. Here we present you how to configure such feature in 2.4GHz, which also applies to 2.4GHz.



Before configuring the WDS Setting page, you have to select the wireless mode to “**WDS**” on the **WLAN2 (2.4GHz)** -> **Basic Settings** web page.

### Wireless Basic Settings - WLAN2 (2.4GHz)

Disable Wireless LAN Interface

Band:

Mode:

Network Type:

SSID:

Channel Width:

Figure 5-70 WDS Mode – 2.4GHz

Choose menu “**WLAN2 (2.4GHz) → WDS Settings**” to configure WDS to connect the WDAP-C7200AC/WDAP-W7200AC with another AP on this page. After the configuration, please “**Apply Changes**” to save the settings.

### WDS Settings - WLAN2 (2.4GHz)

Wireless Distribution System uses wireless media to communicate with other APs, like the Ethernet does. To do this, you must set these APs in the same channel and set MAC address of other APs which you want to communicate with in the table and then enable the WDS.

Enable WDS

MAC Address:

Data Rate:

Comment:

**Current WDS AP List:**

MAC Address	Tx Rate (Mbps)	Comment	Select
00:30:4f:11:11:11	Auto	peer-1	<input type="checkbox"/>
00:30:4f:22:22:22	Auto	peer-2	<input type="checkbox"/>
00:30:4f:33:33:33	Auto	peer-3	<input type="checkbox"/>
00:30:4f:44:44:44	Auto	peer-4	<input type="checkbox"/>
00:30:4f:55:55:55	Auto	peer-5	<input type="checkbox"/>
00:30:4f:66:66:66	Auto	peer-6	<input type="checkbox"/>
00:30:4f:77:77:77	Auto	peer-7	<input type="checkbox"/>
00:30:4f:88:88:88	Auto	peer-8	<input type="checkbox"/>

Figure 5-71 WDS Settings – 2.4GHz

### WDS Security Setup -wlan2

This page allows you setup the wireless security for WDS. When enabled, you must make sure each WDS device has adopted the same encryption algorithm and Key.

---

Encryption:

WEP Key Format:

WEP Key:

Pre-Shared Key Format:

Pre-Shared Key:

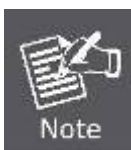
Figure 5-72 WDS – Set Security

The page includes the following fields:

Object	Description
<b>Enable WDS</b>	Check the box to enable the WDS function. Please select <b>WDS</b> or <b>AP+WDS</b> in the Mode of <b>Wireless Basic Settings</b> before you enable WDS on this page.
<b>MAC Address</b>	You can enter the MAC address of the AP you want to connect with.
<b>Data Rate</b>	Default is “ <b>Auto</b> ”.
<b>Comment</b>	You can make some comment for each MAC address on the list.
<b>Set Security</b>	Click “ <b>Set Security</b> ” to configure the wireless security parameters of the AP you want to connect via WDS.
<b>Show Statics</b>	Click “ <b>Show Statics</b> ” to show the WDS AP.
<b>Current WDS AP List</b>	You can select some MAC addresses of the AP and click “ <b>Delete Selected</b> ” to delete it.



WDS feature can only be implemented between 2 wireless devices that both support the WDS feature. Plus, **channel**, **security settings** and **security key** must be **the same** on both such devices.




To encrypt your wireless network, click “**Set Security**”. For the detail of wireless security, see [section 5.5.4](#). Do remember to reboot the device after you save your wireless security settings; otherwise, the WDS feature may not function.

### 5.5.7 Site Survey


Choose menu “**WLAN2 (2.4GHz) → Site Survey**” to scan the available local AP. If any Access Point is found, you could choose any one to connect with manually when the **Client Mode** is enabled.

## Wireless Site Survey - WLAN2 (2.4GHz)


This page provides tool to scan the wireless network. If any Access Point or IBSS is found, you could choose to connect it manually when client mode is enabled.



Wireless Router



Recommended Signal Strength >70%



Range Extender

SSID	BSSID	Channel	Type	Encrypt	Signal	Select
WDRT-1200AC-5G	00:30:4f:74:20:08	6 (B+G+N)	AP	WPA2-PSK	78	<input type="radio"/>
WDRT-1200AC-5G	00:30:4f:76:20:08	6 (B+G+N)	AP	WPA2-PSK	78	<input type="radio"/>
WiFiRepeater-001	00:30:4f:91:1c:44	1 (B+G+N)	AP	no	60	<input type="radio"/>
Default_2.4G_1	00:30:4f:b4:c4:a0	11 (B+G+N)	AP	WPA2-PSK	52	<input checked="" type="radio"/>
WDRT-1200AC-2.4G	00:30:4f:1c:7e:e4	6 (B+G+N)	AP	WPA2-PSK	44	<input type="radio"/>
ADN-4100_ENM	00:30:4f:9c:a3:25	1 (B+G+N)	AP	WPA-PSK/WPA2-PSK	44	<input type="radio"/>
PLANET_11F_AP	00:30:4f:81:ed:88	11 (B+G+N)	AP	WPA2-PSK	29	<input type="radio"/>

Figure 5-73 Site Survey – 2.4GHz

### 5.5.8 WPS

**WPS (Wi-Fi Protected Setup)** is designed to ease setup of security Wi-Fi networks and subsequently network management. This Wireless Router supports WPS features for **AP mode**, **AP+WDS mode**, **Infrastructure-Client mode**, and the wireless root interface of **Universal Repeater mode**.

Simply enter a Pin code or press the software PBC button or hardware WPS button (if any) and a secure wireless connection is established.

- **PBC:** If you find the WPS LED blinking for 2 minutes after you press the hardware WPS button on the device, it means that PBC encryption method is successfully enabled. And an authentication will be performed between your router and the WPS/PBC-enabled wireless client device during this time; if it succeeds, the wireless client device connects to your device, and the WPS LED turns off. Repeat steps mentioned above if you want to connect more wireless client devices to the device.
- **Pin :** To use this option, you must know the Pin code from the wireless client and enter it in corresponding field on your device while using the same Pin code on client side for such connection.

The page includes the following fields:

Object	Description
<b>Disable WPS</b>	You can check the box to disable the WPS function.
<b>WPS Status</b>	Here you can check if the connection via WPS is established or not.
<b>Self-Pin Number</b>	It is the Pin number of the WDAP-C7200AC/WDAP-W7200AC here.
<b>Push Button Configuration</b>	Click <b>“Start PBC”</b> to activate WPS as well in the client device within 2 minutes.
<b>Client Pin Number</b>	In addition to the PBC method, you can also use the Pin method to activate the WPS. Just enter the Pin number of the client device in the field and click <b>“Start Pin”</b> .



The WPS encryption can be implemented only between your Router and another WPS-capable device.

- Example of how to establish wireless connection using **WPS**. Please take the following steps:

**Step 1.** Choose menu **“WLAN2 (2.4GHz) → WPS”** to configure the setting for WPS. After the configuration, please click **“Apply Changes”** to save the settings.

**Step 2.** Add a new device.

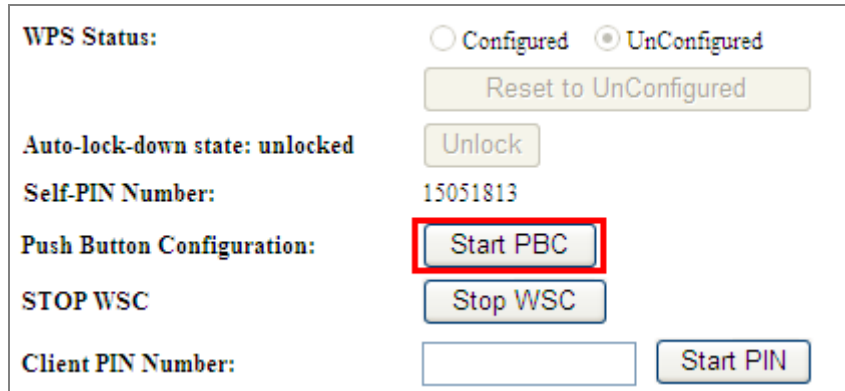
If the wireless adapter supports Wi-Fi Protected Setup (WPS), you can establish a wireless connection between wireless adapter and AP using either Push Button Configuration (PBC) method or Pin method.



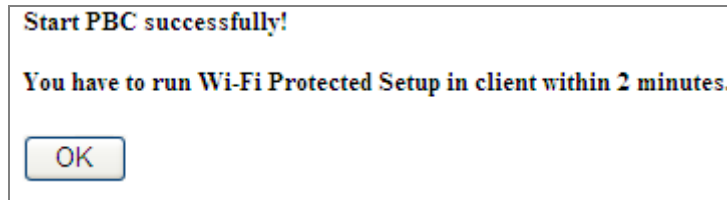
To build a successful connection by WPS, you should also do the corresponding configuration of the new device for WPS function.

**A. By Push Button Configuration (PBC)**

- i. Click “**Start PBC**” on the WPS page of the AP.



**Figure 5-74** WPS-PBC – 2.4GHz-1



**Figure 5-75** WPS-PBC – 2.4GHz-2

- ii. Press and hold the WPS button equipped on the adapter directly for 2 or 3 seconds. Or you can click the WPS button with the same function in the configuration utility of the adapter. The process must be finished within 2 minutes.
- iii. Wait for a while until the next screen appears. Click **OK** to complete the WPS configuration.

**B. By Pin**

If the new device supports Wi-Fi Protected Setup and the Pin method, you can add it to the network by Pin with the following two methods.

**Method One:** Enter the Pin of your wireless adapter into the configuration utility of the AP

- i. Enter the Pin code of the wireless adapter in the field behind **Client Pin Number** in the following figure and then click **Start Pin**.



The Pin code of the adapter is always displayed on the WPS configuration screen.



WPS Status:  Configured  UnConfigured  
 Reset to UnConfigured

Auto-lock-down state: unlocked

Self-PIN Number: 15051813

Push Button Configuration:

STOP WSC

Client PIN Number:

Figure 5-76 WPS-Pin – 2.4GHz-1

Applied WPS PIN successfully!  
 You have to run Wi-Fi Protected Setup within 2 minutes.

Figure 5-77 WPS-Pin – 2.4GHz-2

- ii. For the configuration of the wireless adapter, please choose the option that you want to **enter Pin into the AP (Enrollee)** in the configuration utility of the WPS and click **Next** until the process finishes.

**Method Two:** Enter the Pin of the AP into the configuration utility of your wireless adapter

- i. Click “**Start PBC**” on the WPS page of the AP. Get the current Pin code of the AP on [WPS page](#) (each AP has its unique Pin code).

WPS Status:  Configured  UnConfigured  
 Reset to UnConfigured

Auto-lock-down state: unlocked

**Self-PIN Number: 15051813** Enter this PIN into the wireless adapter's configuration page.

Push Button Configuration:

STOP WSC

Client PIN Number:

Figure 5-78 WPS-Pin – 2.4GHz-3

- ii. For the configuration of the wireless adapter, please choose the option that you want to **enter the Pin of the AP (Registrar)** in the configuration utility of the wireless adapter and enter it into the field. Then click **Next** until the process finishes.

### 5.5.9 Schedule

Wireless Schedules will enable or disable your wireless access at a set time based on your predefined schedule. This feature is often used for restricting access to all users (such as children, employees and guests) during specific times of the day for parental control or security reasons.

Choose menu **"WLAN2 (2.4GHz) → Schedule"** to configure the schedule rule of enabling wireless function. After the configuration, please click **"Apply Changes"** to save the settings.

### Wireless Schedule - WLAN2 (2.4GHz)

This page allows you setup the wireless schedule rule. Please do not forget to configure system time before enable this feature.

**Enable Wireless Schedule**

**Schedulable Wireless ON/OFF Control**

Enable	Day	From		To	
<input type="checkbox"/>	Sun	00 (hour)	00 (min)	00 (hour)	00 (min)
<input type="checkbox"/>	Sun	00 (hour)	00 (min)	00 (hour)	00 (min)
<input type="checkbox"/>	Sun	00 (hour)	00 (min)	00 (hour)	00 (min)
<input type="checkbox"/>	Sun	00 (hour)	00 (min)	00 (hour)	00 (min)
<input type="checkbox"/>	Sun	00 (hour)	00 (min)	00 (hour)	00 (min)
<input type="checkbox"/>	Sun	00 (hour)	00 (min)	00 (hour)	00 (min)
<input type="checkbox"/>	Sun	00 (hour)	00 (min)	00 (hour)	00 (min)
<input type="checkbox"/>	Sun	00 (hour)	00 (min)	00 (hour)	00 (min)
<input type="checkbox"/>	Sun	00 (hour)	00 (min)	00 (hour)	00 (min)
<input type="checkbox"/>	Sun	00 (hour)	00 (min)	00 (hour)	00 (min)
<input type="checkbox"/>	Sun	00 (hour)	00 (min)	00 (hour)	00 (min)

Figure 5-79 Schedule – 2.4GHz



When setting the Wireless Schedule, it is important to ensure that your **System Clock** settings have been configured. If not, your Wireless Schedule will not function correctly.

## 5.6 Management

This section focuses on how to maintain AP, including Restore to Factory Default Setting, Backup/Restore, Firmware Upgrade, Reboot, Password Change and Syslog.

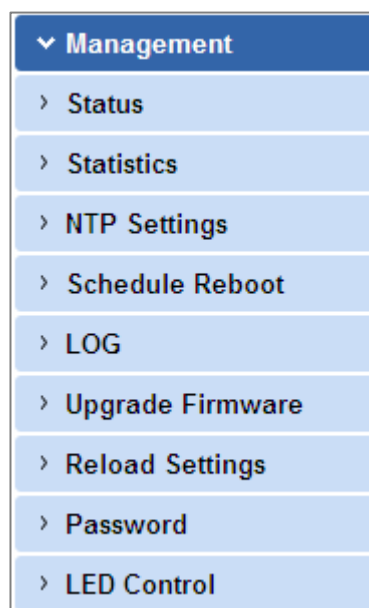


Figure 5-80 Management – Main Menu

### 5.6.1 Status

You can use this function to realize the instantaneous information of the wireless AP. The information displayed here may vary on different configurations.

Choose menu “**Management** → **Status**” to show the current status and some basic settings of the WDAP-C7200AC/WDAP-W7200AC.

## Access Point Status

---

System	
Uptime	0day:1h:28m:36s
Firmware Version	WDAP-C7200AC_v20140425
Build Time	Wed Mar 5 21:16:12 CST 2014
Wireless 1 Configuration	
Mode	AP
Band	5 GHz (A+N+AC)
SSID	Planet AP 5G
Channel Number	149
Encryption	WPA2
BSSID	00:30:4f:77:88:9a
Associated Clients	0
Wireless 2 Configuration	
Mode	AP
Band	2.4 GHz (B+G+N)
SSID	Planet AP 2.4G
Channel Number	11
Encryption	WPA2
BSSID	00:30:4f:77:88:9b
Associated Clients	0
LAN Configuration	
Attain IP Protocol	Fixed IP
IP Address	192.168.1.253
Subnet Mask	255.255.255.0
Default Gateway	192.168.1.254
DHCP Server	Disabled
MAC Address	00:30:4f:77:88:99

Figure 5-81 Status

### 5.6.2 Statistics

Choose menu “**Management → Statistics**” to show the packet counters for transmission and reception regarding wireless and Ethernet network.

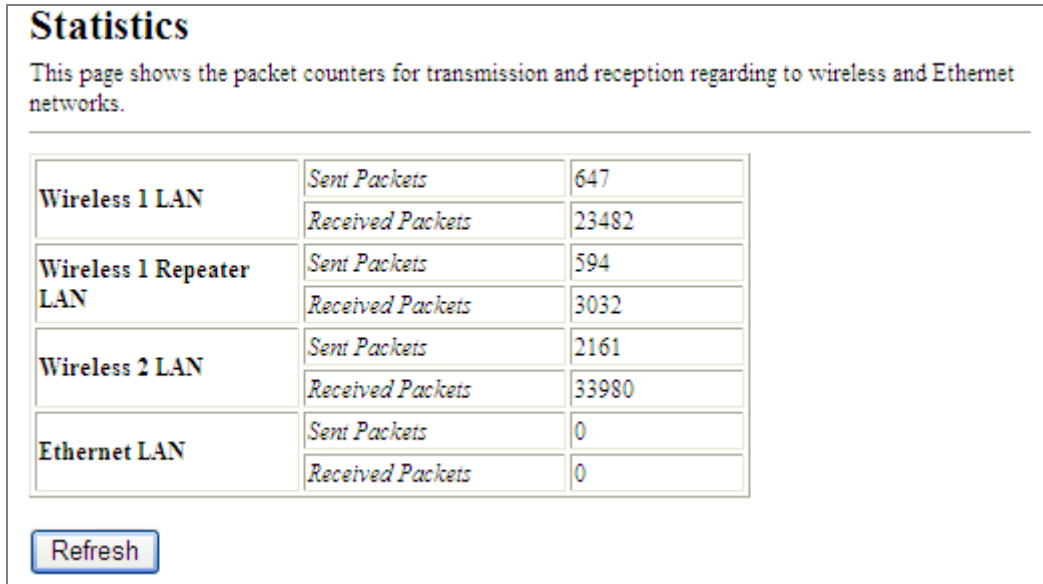


Figure 5-82 Statistics

The page includes the following fields:

Object	Description
Wireless LAN <b><i>Sent Packets</i></b>	It shows the statistic count of sent packets on the wireless LAN interface.
Wireless LAN <b><i>Received Packets</i></b>	It shows the statistic count of received packets on the wireless LAN interface.
Ethernet WAN <b><i>Sent Packets</i></b>	It shows the statistic count of sent packets on the Ethernet WAN interface.
Ethernet WAN <b><i>Received Packets</i></b>	It shows the statistic count of received packets on the Ethernet WAN interface.
Refresh	Click the refresh the statistic counters on the screen.

### 5.6.3 SNMP

Choose menu “**Management → SNMP**” to enable SNMP to allow the network management station to retrieve statistics and status from the SNMP agent in the AP. Simple Network Management Protocol (SNMP) is a popular network monitoring and management protocol, used to refer to a collection of specifications for network management that includes the protocol itself.

## SNMP Setting

SNMP is a application for network management

---

Enable SNMP

Name :

Location :

Contact :

Read/Write Community :

Read-Only Community :

Trap Receiver IP Address:

Figure 5-83 SNMP

The page includes the following fields:

Object	Description
<b>Enable SNMP</b>	It shows the statistic count of sent packets on the wireless LAN interface.
<b>Name</b>	An administratively-assigned name for this managed node.
<b>Location</b>	The physical location of this node.
<b>Contact</b>	The textual identification of the contact person for this managed node.
<b>Read/Write Community</b>	Enter the community name that allows Read/Write access to the AP's SNMP information. The community name can be considered a group password. The default setting is “ <b>private</b> ”.
<b>Read-Only Community</b>	Enter the community name that allows Read-Only access to the AP's SNMP information. The community name can be considered a group password. The default setting is “ <b>public</b> ”.
<b>Trap Receiver IP Address</b>	Enter the IP address s of the SNMP trap receiver.
<b>Apply Change</b>	Click “Apply Change” to save and apply the settings.
<b>Reset</b>	Click “Reset” to reset the values to default.

### 5.6.4 NTP Settings

This section assists you in setting the Wireless AP's system time. You can either select to set the time and date manually or automatically obtain the GMT time from Internet.

Choose menu “**Management → NTP Settings**” to configure the system time. You can also maintain the system time by synchronizing with a public time server over the Internet. After the configuration, please click “**OK**” to save the settings.



The configured time and date settings are lost when the wireless AP is powered off.

### Time Zone Setting

You can maintain the system time by synchronizing with a public time server over the Internet.

**Current Time :**    2014 / 3 / 6 (YYYY/MM/DD)  
                           1 : 13 : 46 (hh:mm:ss)

**Time Zone Select :**    (GMT-08:00)Pacific Time (US & Canada); Tijuana ▼

Automatically Adjust Daylight Saving

Enable NTP client update

**NTP server :**     192.5.41.209 - North America ▼  
                             (Manual IP Setting)

**Figure 5-84** Time Zone Settings

The page includes the following fields:

Object	Description
<b>Current Time</b>	Input current time manually. You can click <b>"Copy Computer Time"</b> to copy the PC's current time to the AP.
<b>Time Zone Select</b>	Select the time zone of the country you are currently in. The router will set its time based on your selection.
<b>Automatically Adjust Daylight Saving</b>	Select the time offset, if your location observes daylight saving time.
<b>Enable NTP client update</b>	Check to enable NTP update. Once this function is enabled, AP will automatically update the current time from NTP server.
<b>NTP Server</b>	User may select prefer NTP sever or input address of NTP server manually.



If the AP loses power for any reason, it cannot keep its clock running, and will not have the correct time when it is started again. To maintain correct time for schedules and logs, either you must enter the correct time after you restart the AP, or you must enable the NTP Server option.

### 5.6.5 Schedule Reboot

This page allows you to enable and configure system reboot schedule. The device can regularly reboot according to the reserved time when connecting to the Internet.

## Schedule Reboot

This page allows you to enable and configure system reboot schedule. The device can regularly reboot according to the reserved time when connecting to the Internet.

**Schedule Reboot Setting:**  Enable  Disable

**Reboot Time:**  (Hour: Minute, ex: 02:23, or 13:14)

**Reboot Plan:**  ▾

**Weekday:**  SUN.  MON.  TUE.  WED.  THUR.  FRI.  SAT.

Figure 5-85 Schedule Reboot



The page includes the following fields:

Object	Description
<b>Schedule Reboot Setting</b>	Enable or disable the Schedule Reboot function.
<b>Reboot Time</b>	Enter the Reboot Time (24-hour format) to enable this function to take effect.
<b>Reboot Plan</b>	There are two Reboot Plans supported in the AP:  <b>Weekday:</b> select this option to let the device reboot automatically according to the reserved time in one or more days of a week.  <b>Every day:</b> select this option to let the device reboot automatically according to the reserved time every day.
<b>Weekday</b>	Check one or more days to let the device auto reboot on schedule.  When choosing "Every day" as your reboot plan, the "Weekday" will be grayed out (disabled), which means Every day will auto reboot at the time that you schedule.



1. This setting will only take effect when the Internet connection is accessible and the GMT time is configured correctly.
2. You must select at least one day when choosing "**Weekday**" as your reboot plan.
3. When choosing "**Every day**" as your reboot plan, the "**Weekday**" will be grayed out (disabled), which means **Every day** will auto reboot at the time that you schedule.

■ Example of how to configure **Schedule Reboot**. Please take the following steps:

Before configured schedule reboots, please ensure the Internet connection is accessible and the GMT time is configured correctly according to **NTP Settings** page.

**Step 1.** Select the Schedule Reboot Setting checkbox.

**Step 2.** Enter the Reboot Time (24-hour format) to enable this function to take effect. For example, if you want this function to work at 23:00 every Sunday, choose "Weekday" in the Reboot Plan field.

## Schedule Reboot

This page allows you to enable and configure system reboot schedule. The device can regularly reboot according to the reserved time when connecting to the Internet.



**Schedule Reboot Setting:**  Enable  Disable

**Reboot Time:**  (Hour: Minute, ex: 02:23, or 13:14)

**Reboot Plan:**

**Weekday:**  SUN.  MON.  TUE.  WED.  THUR.  FRI.  SAT.

Figure 5-86 Schedule Reboot - Example

**Step 3.** Click "Apply Changes" to take this function effect.

### 5.6.6 LOG

Choose menu “**Management → LOG**” to configure the settings of system log. You can check the box of the items you want to record it in the log. After the configuration, please click “**Apply**” to save the settings.

## System Log

This page can be used to set remote log server and show the system log.

---

**Enable Log**

**System all**
 **Wireless**

**Enable Remote Log**

**Log Server IP Address:**

```

Mar  6 02:01:52 wlan0-vxd: Open and authenticated
Mar  6 02:01:52 wlan0-vxd: Roaming...
Mar  6 02:01:52 wlan0-vxd: WPA-none PSK authentication in progress...
Mar  6 02:01:52 wlan0-vxd: Open and authenticated
Mar  6 02:01:52   Register Realtek Simple Config
Mar  6 02:01:52   [phy_RF6052_Config_ParaFile] [RadioA_8812_n_ultra_hp]
Mar  6 02:01:52   [phy_RF6052_Config_ParaFile] [RadioB_8812_n_ultra_hp]
Mar  6 02:01:52   <=== FirmwareDownload8812 ()
Mar  6 02:01:52   [ 5G] : AntDiv Type = CG_TRX_HW_ANTDIV
Mar  6 02:01:52   Register Realtek Simple Config
Mar  6 02:01:52   Register Realtek Simple Config
Mar  6 02:01:52   Register Realtek Simple Config
Mar  6 02:02:07 wlan0-vxd: WPA-none PSK authentication in progress...
Mar  6 02:02:07 wlan0-vxd: Open and authenticated
                
```

**Figure 5-87** System Log

The page includes the following fields:

Object	Description
<b>Enable Log</b>	Check to enable log function.
<b>System all</b>	Check this option to display all the system logs.
<b>Wireless</b>	Check this option to display only the logs related to wireless module.
<b>Enable Remote Log</b>	Enable this option if you have a syslog server currently running on the LAN and wish to send log messages to it.
<b>Log Server IP Address</b>	Enter the LAN IP address of the Syslog Server.
<b>Refresh</b>	Click this button to update the log.
<b>Clear</b>	Click this button to clear the current log.

### 5.6.7 Upgrade Firmware

This page allows you to upgrade the Access Point firmware to new version. Please note, do not power off the device during the upload because it may crash the system.

Choose menu “**Management → Upgrade Firmware**” to upgrade the firmware of the WDAP-C7200AC/WDAP-W7200AC. Select the new firmware file downloaded from the PLANET website and then click “**Upload**” to upgrade it.

### Upgrade Firmware

This page allows you upgrade the Access Point firmware to new version. Please note, do not power off the device during the upload because it may crash the system.

---

Software Version: WDAP-C7200AC\_v20140425

Select File:

Figure 5-88 Upgrading Firmware

The page includes the following fields:

Object	Description
<b>Select File</b>	Browse and select file you want to upgrade and press Upload to perform upgrade.  <b>Please wait till the related information is shown on the screen after upgrade is finished.</b>



Do not disconnect the wireless AP from your management PC (the PC you use to configure the device) or power off it during the upgrade process; otherwise, it may be permanently damaged. The wireless AP will restart automatically after the upgrade process completes in several minutes.

### 5.6.8 Reload Settings

Choose menu “**Management → Reload Settings**” to back up or reset the configuration of the WDAP-C7200AC/WDAP-W7200AC.

Once you have configured the Wireless AP the way you want it, you can save these settings to a configuration file on your local hard drive that can later be imported to your Wireless AP in case the device is restored to factory default settings.

### Save/Reload Settings

This page allows you save current settings to a file or reload the settings from the file which was saved previously. Besides, you could reset the current configuration to factory default.

---

Save Settings to File:

Load Settings from File:

Reset Settings to Default:

**Figure 5-89** Save/Reload Settings

The page includes the following fields:

Object	Description
<b>Save Settings to File</b>	Click <b>“Save...”</b> to back up the configuration of the WDAP-C7200AC/WDAP-W7200AC and then save the “config.dat” in your computer.
<b>Load Settings from File</b>	Select the configuration file of the WDAP-C7200AC/WDAP-W7200AC and then click <b>“Upload”</b> to reload the configuration back into the WDAP-C7200AC/WDAP-W7200AC.
<b>Reset Settings to Default</b>	<p>Click <b>“Reset”</b> to reset all settings of the WDAP-C7200AC/WDAP-W7200AC to factory default.</p> <p><b>Factory Default Settings:</b></p> <div style="background-color: #e0e0e0; padding: 5px;"> <p>User Name: <b>admin</b></p> <p>Password: <b>admin</b></p> <p>IP Address: <b>192.168.1.253</b></p> <p>Subnet Mask: <b>255.255.255.0</b></p> <p>Default Gateway: <b>192.168.1.254</b></p> <p>DHCP: <b>Disabled</b></p> <p>5GHz SSID: <b>Planet AP 5G</b></p> <p>2.4GHz SSID: <b>Planet AP 2.4G</b></p> <p>Wireless Security: <b>None</b></p> </div>



To activate your settings, you need to reboot the wireless AP after you reset it.

### 5.6.9 Password

To ensure the wireless AP's security, you will be asked for your password when you access the wireless AP's Web-based utility. The default user name and password are "admin". This page will allow you to add or modify the user name and password.

Choose menu "**Management → User Management**" to change the user name and password which is inputted to access the web UI of the WDAP-C7200AC/WDAP-W7200AC.

### Password Setup

This page is used to set the account to access the web server of Access Point. Empty user name and password will disable the protection.

---

User Name:

New Password:

Confirmed Password:

**Figure 5-90** Password Setup

The page includes the following fields:

Object	Description
<b>User Name</b>	Enter user name.
<b>New Password</b>	Input password for this user.
<b>Confirmed Password</b>	Confirm password again.



For the sake of security, it is highly recommended that you change default login password and user name.

### 5.6.10 LED Control

This section allows the user to determine the router packets that are talking to a particular host.

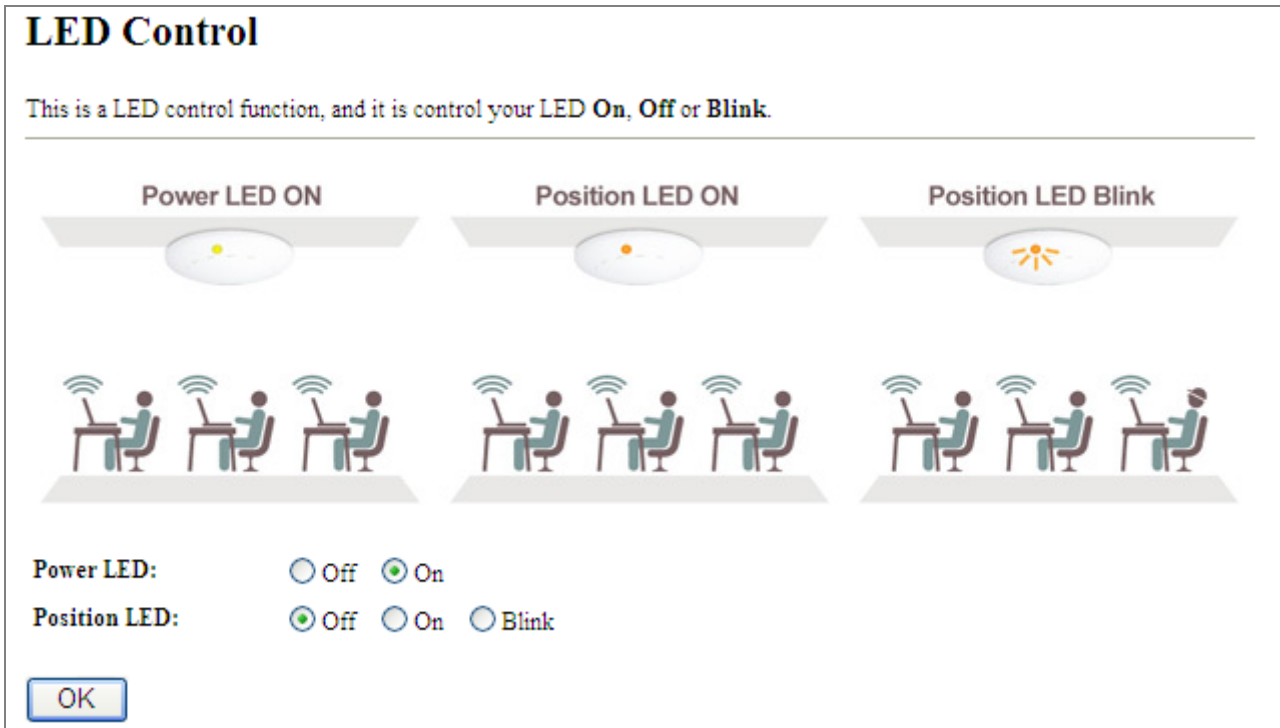


Figure 5-91 LED Control

The page includes the following fields:

Object	Description
Power LED	Click <b>On</b> or <b>Off</b> to turn on/off the Power LED.
Position LED	The LED to detect and identify the AP. 1) Position LED on: the position LED is on. 2) Position LED blink: the position LED blinks continuously. 2) Position LED off: the position LED is off.

### 5.6.11 Logout

To log out the WDAP-C7200AC/WDAP-W7200AC, please select “**Logout**” from the left-side menu.

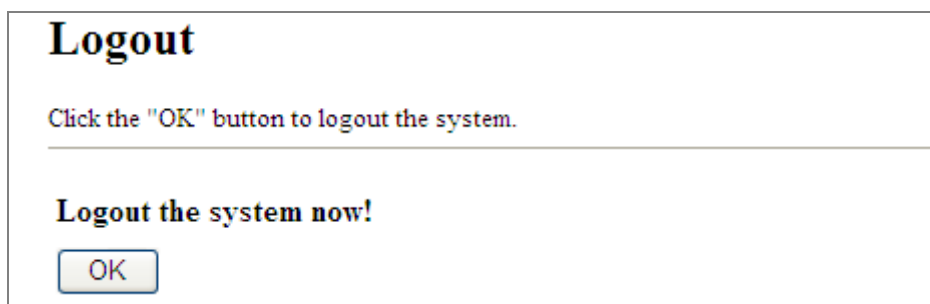
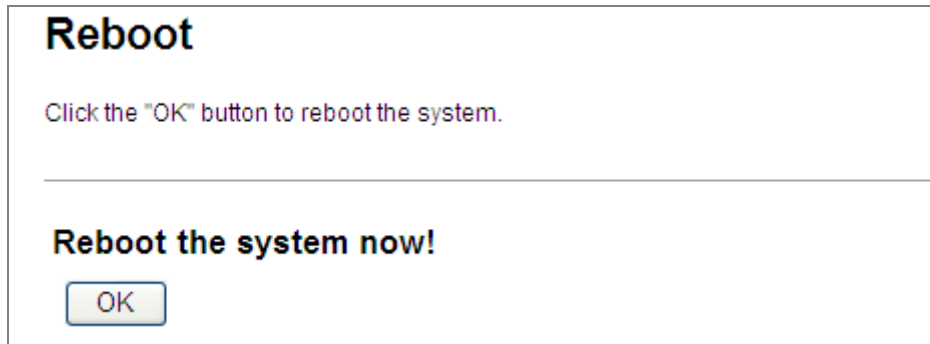


Figure 5-92 Logout

### 5.6.12 Reboot

To reboot the WDAP-C7200AC/WDAP-W7200AC, please select "**Reboot**" from the left-side menu.



**Figure 5-93** Reboot



# Chapter 6. Quick Connection to a Wireless Network

In the following sections, the **default SSID** of the WDAP-C7200AC/WDAP-W7200AC is configured to “**default**”.

## 6.1 Windows XP (Wireless Zero Configuration)

**Step 1:** Right-click on the **wireless network icon** displayed in the system tray



Figure 6-1 System Tray – Wireless Network Icon

**Step 2:** Select [View Available Wireless Networks]

**Step 3:** Highlight and select the wireless network (SSID) to connect

- (1) Select SSID [default]
- (2) Click the [Connect] button

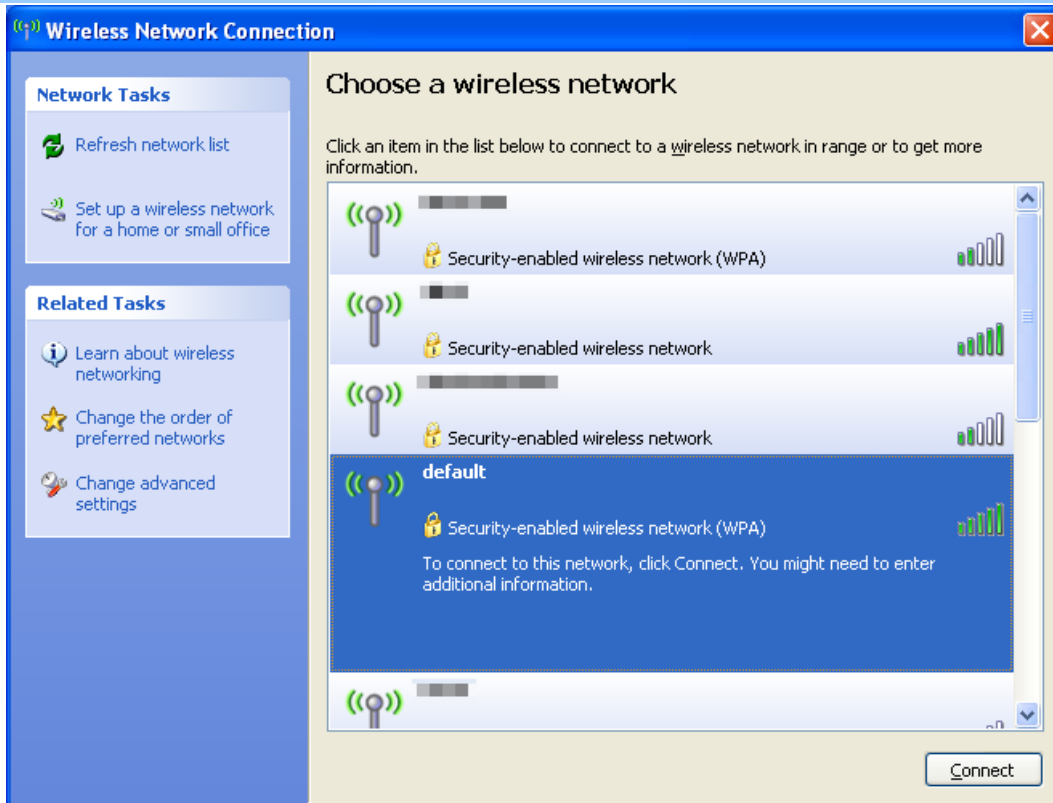


Figure 6-2 Choosing a Wireless Network

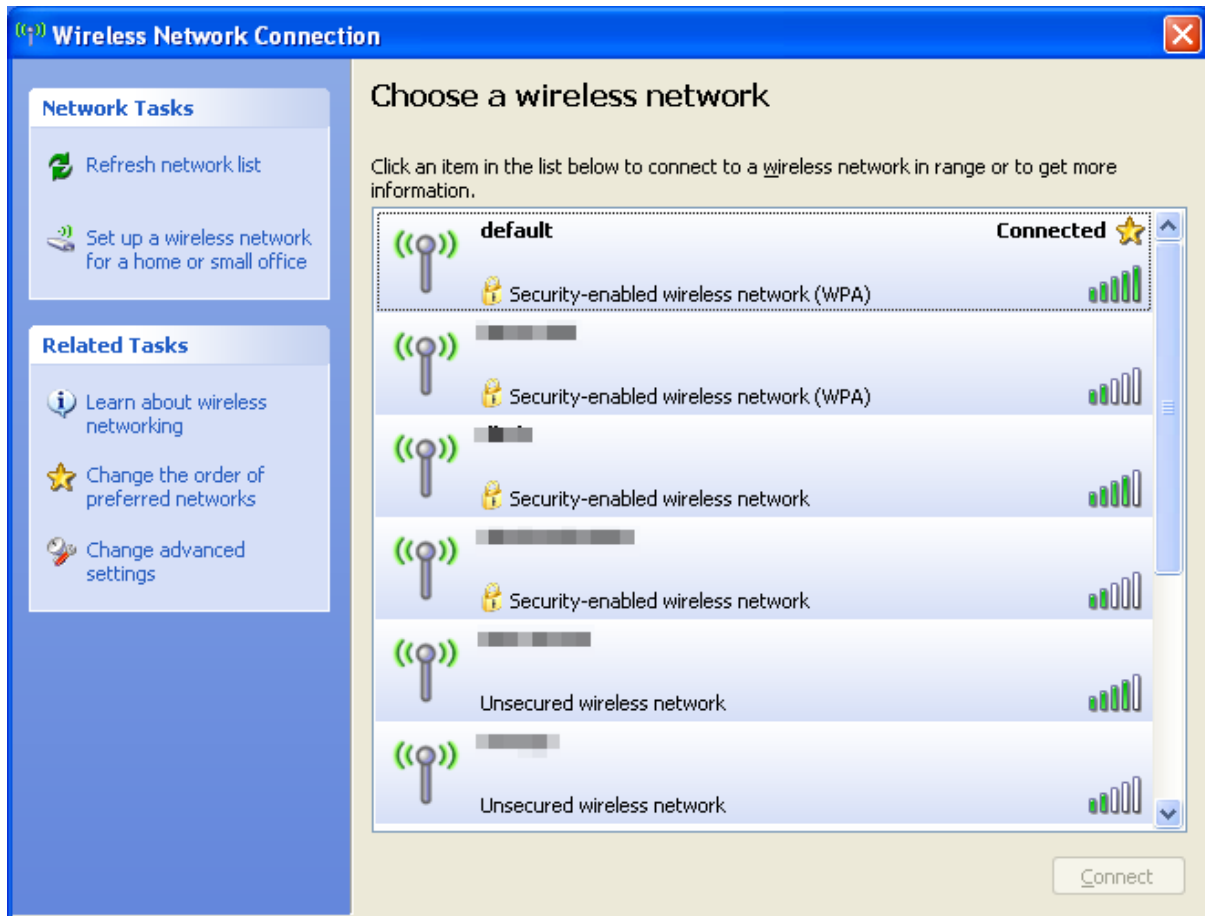
**Step 4:** Enter the **encryption key** of the wireless AP

- (1) The Wireless Network Connection box will appear
- (2) Enter the encryption key that is configured in [section 5.3.3](#)
- (3) Click the [Connect] button



**Figure 6-3** Entering the Network Key

**Step 5:** Check if “**Connected**” is displayed



**Figure 6-4** Choosing a Wireless Network -- Connected



Some laptops are equipped with a “Wireless ON/OFF” switch for the internal wireless LAN. Make sure the hardware wireless switch is switched to “ON” position.

## 6.2 Windows 7 (WLAN AutoConfig)

WLAN AutoConfig service is built-in in Windows 7 that can be used to detect and connect to wireless network. This built-in wireless network connection tool is similar to wireless zero configuration tool in Windows XP.

**Step 1:** Right-click on the **network icon** displayed in the system tray



Figure 6-5 Network Icon

**Step 2:** Highlight and select the wireless network (SSID) to connect

- (1) Select SSID [default]
- (2) Click the [Connect] button

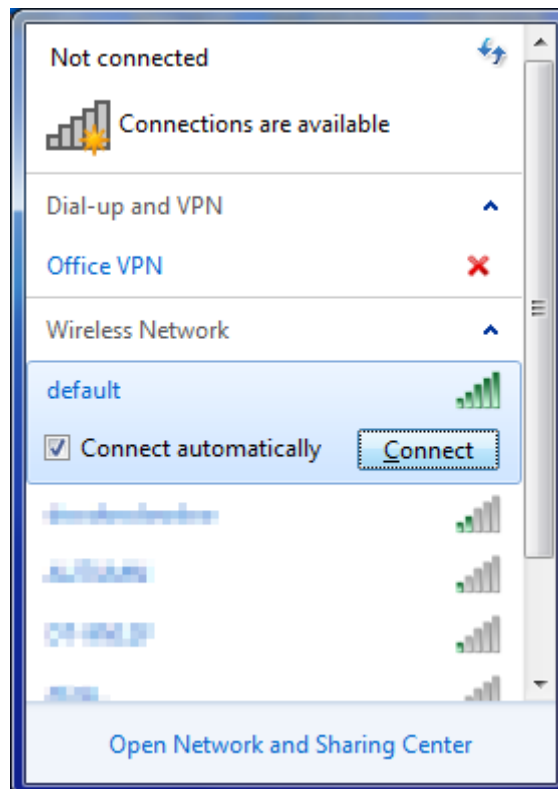


Figure 6-6 WLAN AutoConfig



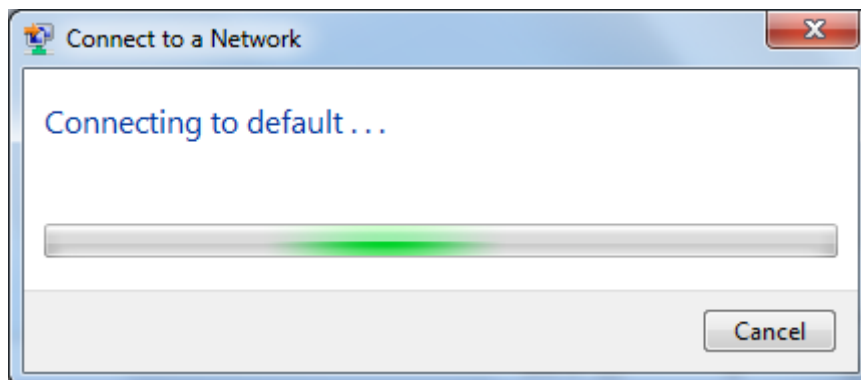
If you will be connecting to this Wireless AP in the future, check **[Connect automatically]**.

**Step 4:** Enter the **encryption key** of the wireless AP

- (1) The Connect to a Network box will appear
- (2) Enter the encryption key that is configured in [section 5.3.3](#)
- (3) Click the [OK] button

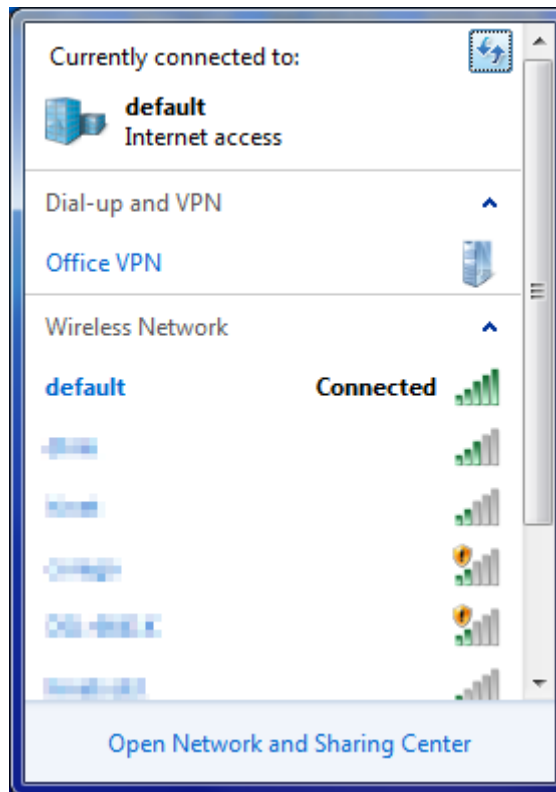


**Figure 6-7** Typing the Network Key



**Figure 6-8** Connecting to a Network

**Step 5:** Check if **“Connected”** is displayed



**Figure 6-9** Connected to a Network

### 6.3 Mac OS X 10.x

In the following sections, the default SSID of the WDAP-C7200AC/WDAP-W7200AC is configured to “default”.

**Step 1:** Right-click on the **network icon** displayed in the system tray

The AirPort Network Connection menu will appear



Figure 6-10 Mac OS – Network Icon

**Step 2:** Highlight and select the wireless network (SSID) to connect

- (1) Select and SSID [**default**]
- (2) Double-click on the selected SSID

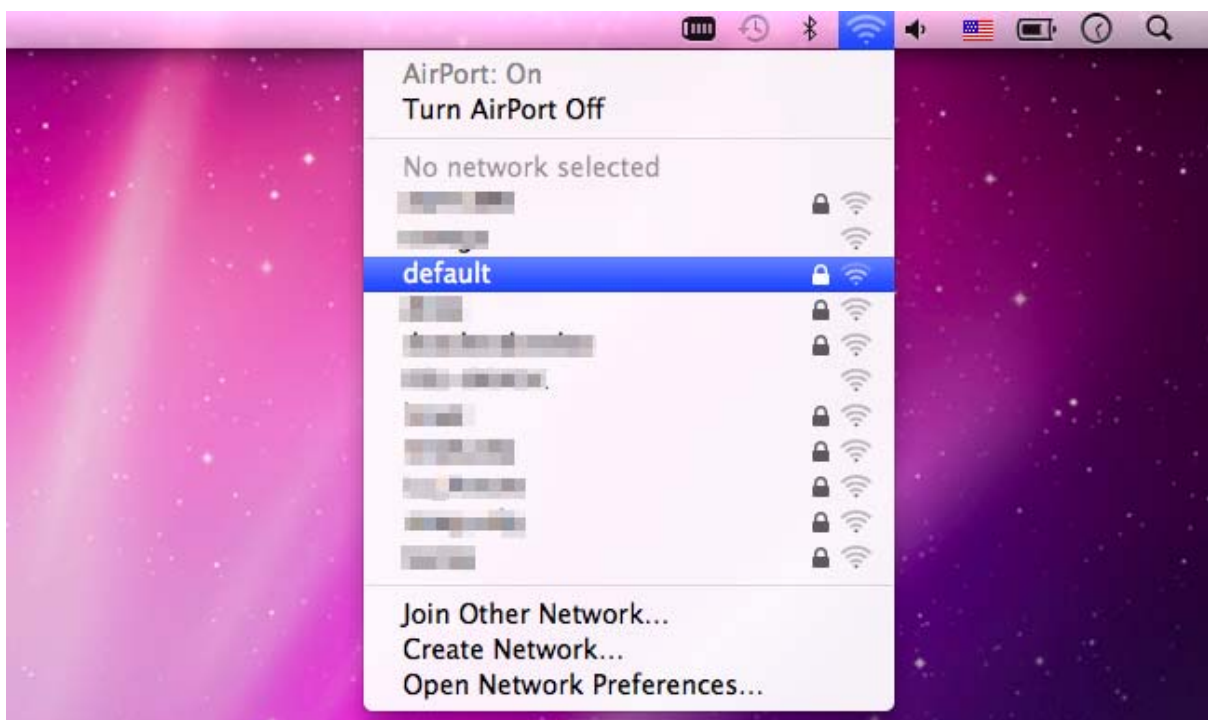


Figure 6-11 Highlighting and Selecting the Wireless Network

**Step 4:** Enter the **encryption key** of the wireless AP

- (1) Enter the encryption key that is configured in [section 5.3.3](#)
- (2) Click the [OK] button



Figure 6-12 Enter the Password



If you will be connecting to this Wireless AP in the future, check **[Remember this network]**.

**Step 5:** Check if the AirPort is connected to the selected wireless network.

If "Yes", then there will be a "check" symbol in front of the SSID.



Figure 6-13 Connected to the Network



There is another way to configure the MAC OS X wireless settings:

**Step 1:** Click and open the [System Preferences] by going to **Apple > System Preference** or **Applications**

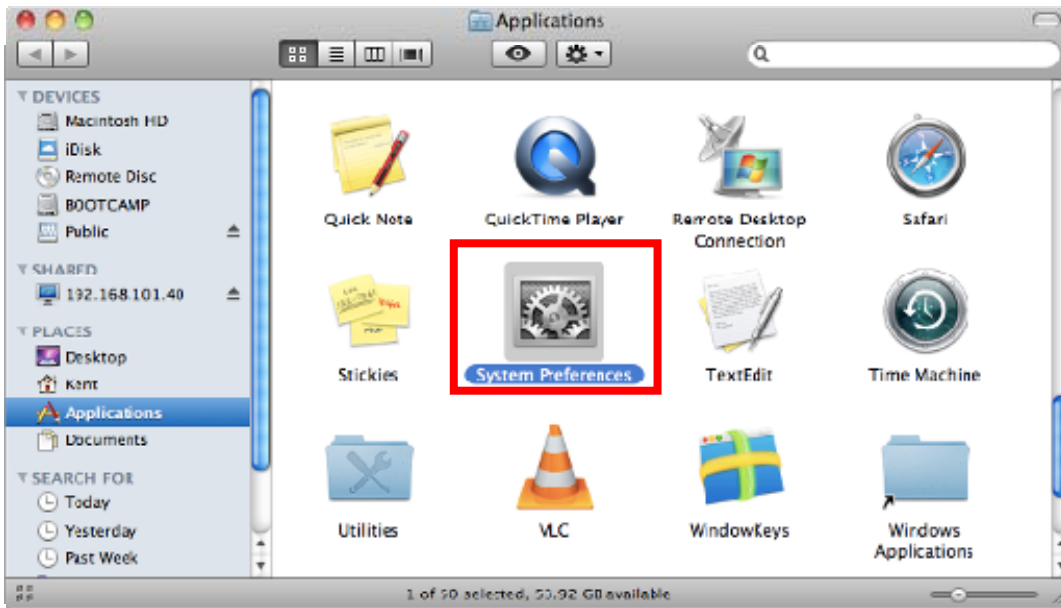


Figure 6-14 System Preferences

**Step 2:** Open **Network Preference** by clicking on the [Network] icon

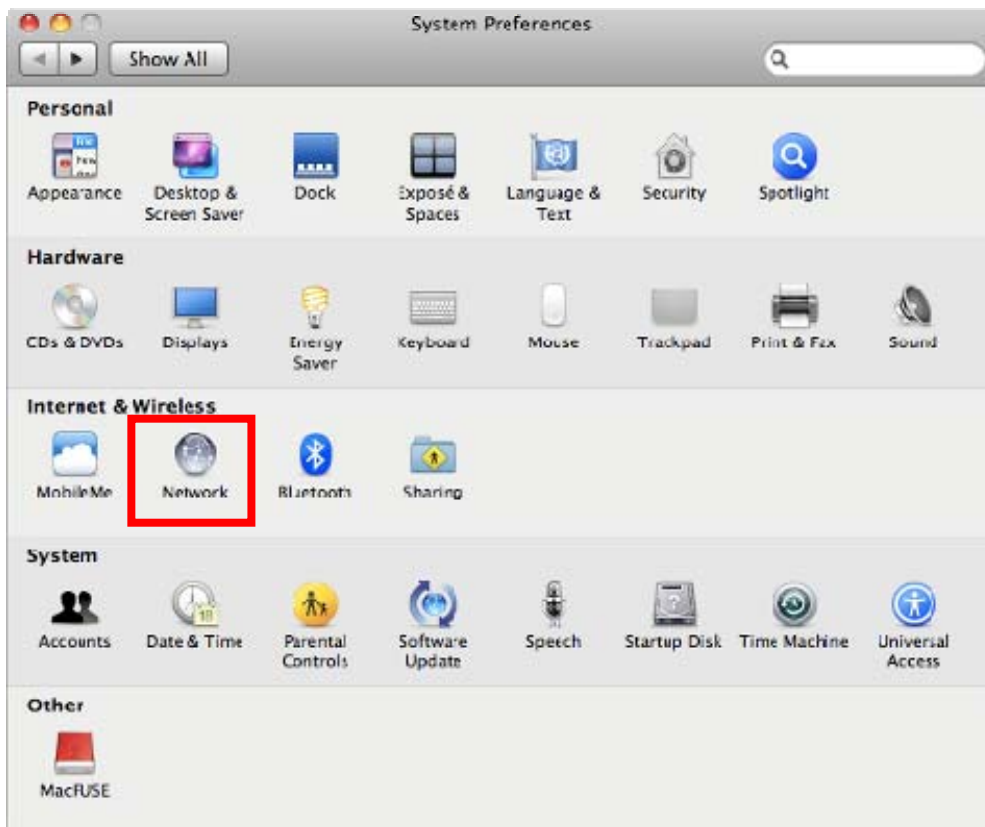


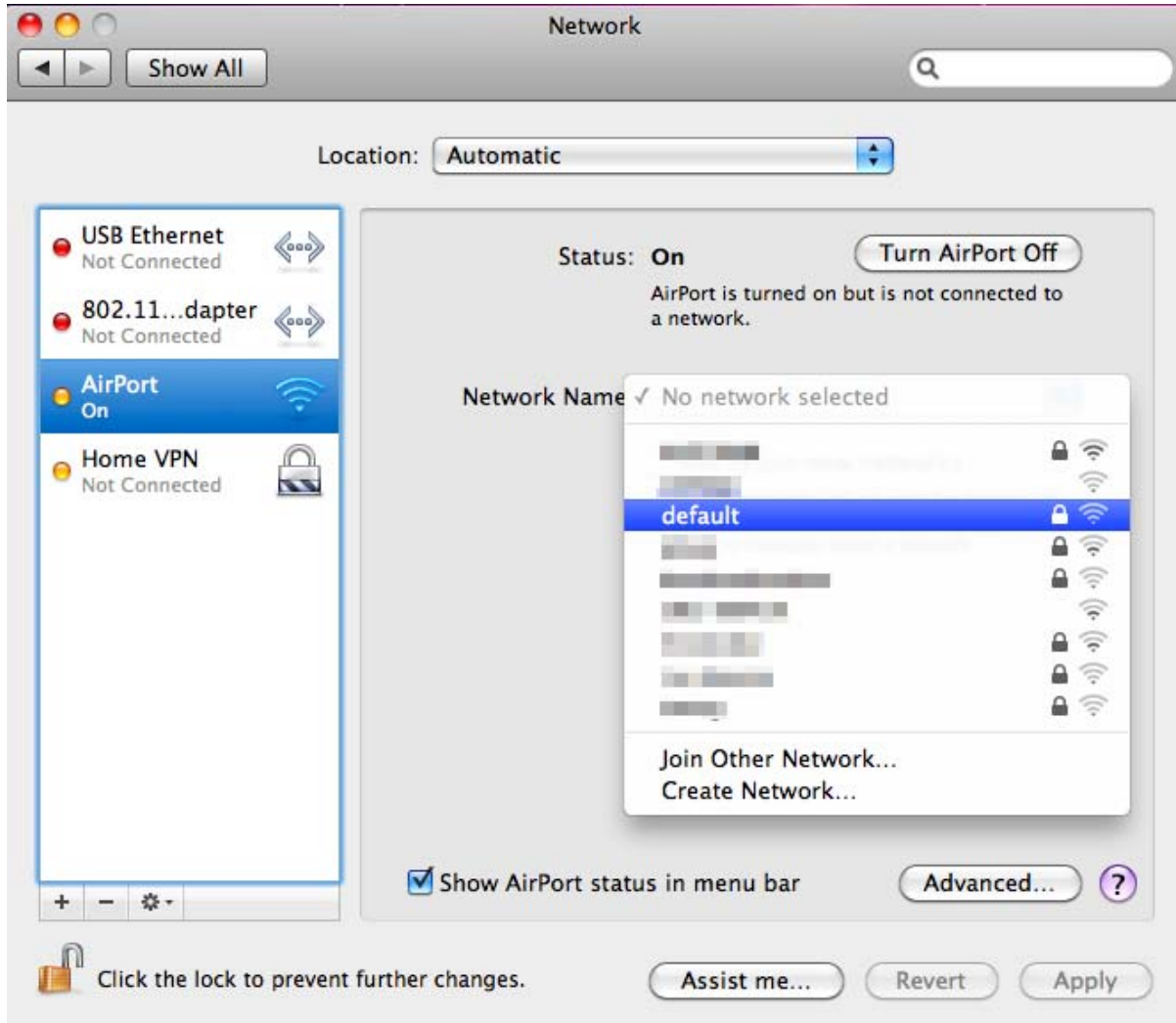
Figure 6-15 System Preferences -- Network



**Step 3:** Check Wi-Fi setting and select the available wireless network

- (1) Choose the **AirPort** on the left-menu (make sure it is ON)
- (2) Select Network Name **[default]** here

If this is the first time to connect to the Wireless AP, it should show “Not network selected”.



**Figure 6-16** Selecting the Wireless Network

## 6.4 iPhone/iPod Touch/iPad

In the following sections, the **default SSID** of the WDAP-C7200AC/WDAP-W7200AC is configured to “**default**”.

**Step 1:** Tap the [Settings] icon displayed in the home screen

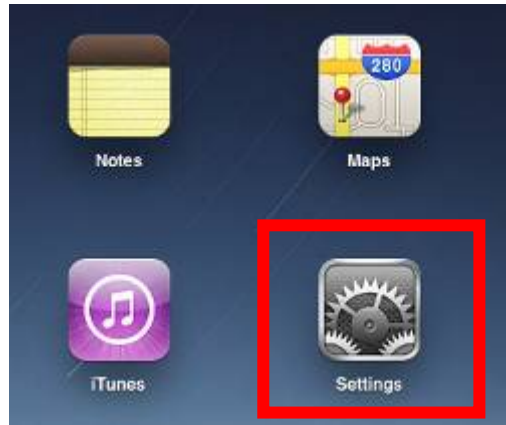


Figure 6-17 iPhone – Settings icon

**Step 2:** Check Wi-Fi setting and select the available wireless network

(1) Tap [General] \ [Network]

(2) Tap [Wi-Fi]

If this is the first time to connect to the Wireless AP, it should show “Not Connected”.



Figure 6-18 Wi-Fi Setting

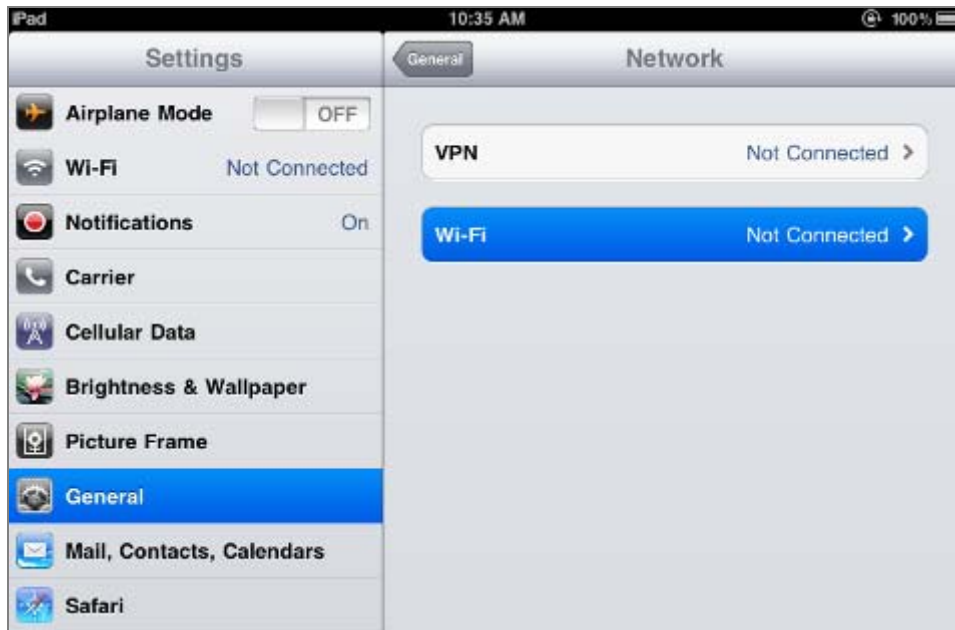


Figure 6-19 Wi-Fi Setting – Not Connected

**Step 3:** Tap the target wireless network (SSID) in “Choose a Network...”

- (1) Turn on Wi-Fi by tapping “Wi-Fi”
- (2) Select SSID [default]



Figure 6-20 Turning on Wi-Fi

**Step 4:** Enter the **encryption key** of the Wireless AP

- (1) The password input screen will be displayed
- (2) Enter the encryption key that is configured in [section 5.3.3](#)
- (3) Tap the [Join] button

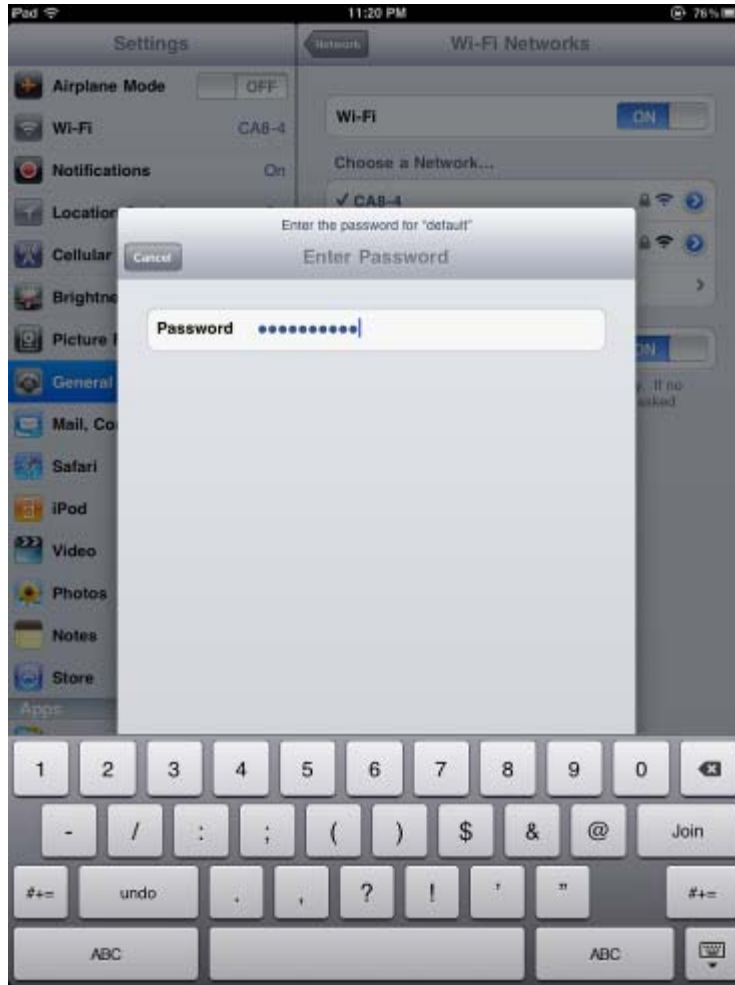


Figure 6-21 iPhone -- Entering the Password

**Step 5:** Check if the device is connected to the selected wireless network.

If "Yes", then there will be a "check" symbol in front of the SSID.



Figure 6-22 iPhone -- Connected to the Network

# Appendix A: Planet Smart Discovery Utility

To easily list the WDAP-C7200AC/WDAP-W7200AC in your Ethernet environment, the Planet Smart Discovery Utility from user’s manual CD-ROM is an ideal solution.

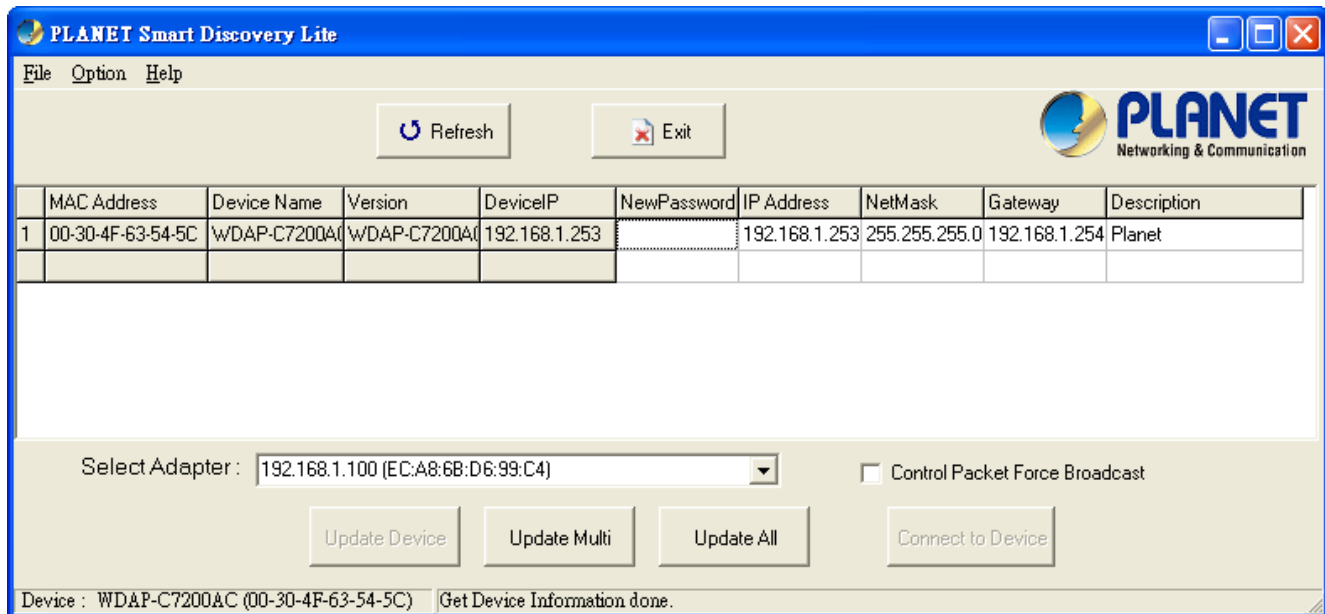
The following installation instructions guide you to running the Planet Smart Discovery Utility.

**Step 1:** Deposit the **Planet Smart Discovery Utility** in administrator PC.

**Step 2:** Run this utility and the following screen appears.



**Step 3:** Press **“Refresh”** for the current connected devices in the discovery list as shown in the following screen:



**Step 3:** Press **“Connect to Device”** and then the Web login screen appears.



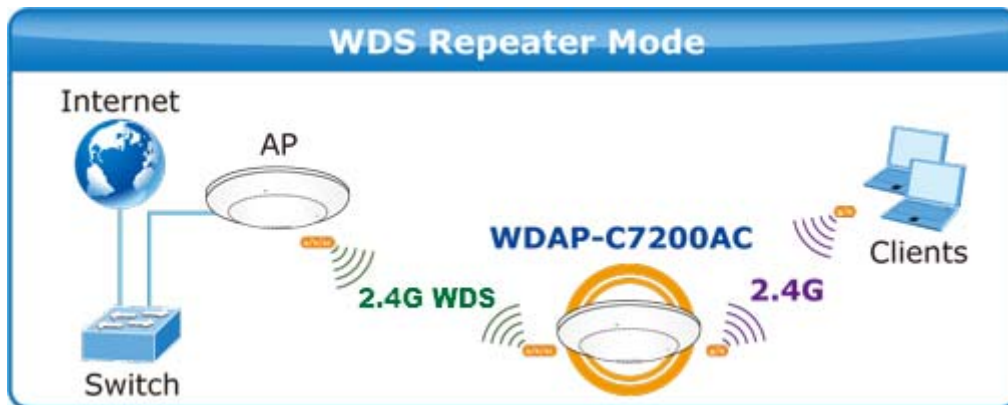
The fields in white background can be modified directly and then you can apply the new setting by clicking **“Update Device”**.

## Appendix B: FAQs

### Q1: How to set up the WDS Repeater Connection

In this case, we use 2.4GHz wireless to connect to the root AP and then repeat the wireless signal by using the 2.4GHz wireless interface to let the 2.4GHz wireless clients surf the internet.

**Topology:**



Note

1. Before configuration, please ensure the 2.4GHz root AP is already connected to the internet and the DHCP server is enabled to let it able to assign IP address to the connected clients.
2. Please ensure there is no IP conflict in the existing network. Otherwise, please re-configure the WDAP-C7200AC using other IP addresses which should be in the same network segment. The default IP address of the WDAP-C7200AC is [192.168.1.253](#).

**Step 1.** In the WDAP-C7200AC-1, go to **“WLAN2 (2.4GHz) → Basic Settings”** to configure wireless mode to **“WDS”** and then configure the channel to a fixed one. Click **“Apply Changes”** to take effect.

### Wireless Basic Settings - WLAN2 (2.4GHz)

Disable Wireless LAN Interface

Band: 2.4 GHz (B+G+N)

**Mode: WDS** MultipleAP

Network Type: Infrastructure

SSID: Planet AP 2.4G Add to Profile

Channel Width: 40MHz

**Step 2.** Go to **“WLAN2 (2.4GHz) → WDS Settings”** page to connect the root AP. Select **“Enable WDS”** and enter the MAC address of the repeater AP. Then, click **“Set Security”** to configure the security setting for the WDS connection. After finishing the configuration, click **“Apply Changes”** to take effect.



**Setup Menu:**

- > Setup Wizard
- > WLAN1 (5 GHz)
- v WLAN2 (2.4 GHz)
- > Basic Settings
- > Advanced Settings
- > RF Output Power
- > Security
- > Access Control
- > WDS Settings
- > Site Survey
- > WPS
- > Schedule

## WDS Settings - WLAN2 (2.4GHz)

Wireless Distribution System uses wireless media to communicate with other APs, like the Ethernet does. To do this, you must set these APs in the same channel and set MAC address of other APs which you want to communicate with in the table and then enable the WDS.

---

Enable WDS  
MAC Address:   
Data Rate:   
Comment:

Current WDS AP List:

MAC Address	Tx Rate (Mbps)	Comment	Select

**Setup Menu:**

- > Setup Wizard
- > WLAN1 (5 GHz)
- v WLAN2 (2.4 GHz)
- > Basic Settings
- > Advanced Settings
- > RF Output Power
- > Security
- > Access Control
- > WDS Settings
- > Site Survey
- > WPS
- > Schedule

## WDS Security Setup -wlan2

This page allows you setup the wireless security for WDS. When enabled, you must make sure each WDS device has adopted the same encryption algorithm and Key.

---

Encryption:

WEP Key Format:

WEP Key:

Pre-Shared Key Format:

Pre-Shared Key:

**Step 3.** In the WDAP-C7200AC-2, go to “**WLAN2 (2.4GHz) → Basic Settings**” to configure wireless mode to “**AP+WDS**” and then configure the channel to a fixed one which must be the same as the root AP. Click “**Apply Changes**” to take effect.

※ The root AP should be the same model (WDAP-C7200AC) in WDS mode; otherwise, the connection might not be able to be established due to the incompatibility.

**Setup Menu:**

- > Setup Wizard
- > WLAN1 (5 GHz)
- ▼ WLAN2 (2.4 GHz)
- > Basic Settings
- > Advanced Settings
- > RF Output Power
- > Security
- > Access Control
- > WDS Settings
- > Site Survey
- > WPS
- > Schedule

### Wireless Basic Settings - WLAN2 (2.4GHz)

This page is used to configure the parameters for wireless LAN clients which may connect to your Access Point. Here you may change wireless encryption settings as well as wireless network parameters.

---

Disable Wireless LAN Interface

Band: 2.4 GHz (B+G+N)

Mode: AP+WDS MultipleAP

Network Type: Infrastructure

SSID: Planet AP 2.4G Add to Profile

Channel Width: 40MHz

Control Sideband: Upper

Channel Number: 11

Broadcast SSID: Enabled

**Step 4.** Go to “WLAN2 (2.4GHz) → WDS Settings” page to connect the root AP. Select “Enable WDS” and enter the MAC Address of the root AP. Then, click “Set Security” to configure the security setting as the same as the root AP. After finishing the configuration, click “Apply Changes” to take effect.

**Setup Menu:**

- > Setup Wizard
- > WLAN1 (5 GHz)
- ▼ WLAN2 (2.4 GHz)
- > Basic Settings
- > Advanced Settings
- > RF Output Power
- > Security
- > Access Control
- > WDS Settings
- > Site Survey
- > WPS
- > Schedule

### WDS Settings - WLAN2 (2.4GHz)

Wireless Distribution System uses wireless media to communicate with other APs, like the Ethernet does. To do this, you must set these APs in the same channel and set MAC address of other APs which you want to communicate with in the table and then enable the WDS.

---

Enable WDS

MAC Address: a8f7e0001480

Data Rate: Auto

Comment: Root AP

Apply Changes
Reset
Set Security
Show Statistics

Current WDS AP List:

MAC Address	Tx Rate (Mbps)	Comment	Select

Delete Selected
Delete All
Reset



**Setup Menu:**

- > Setup Wizard
- > WLAN1 (5 GHz)
- ▼ **WLAN2 (2.4 GHz)**
- > Basic Settings
- > Advanced Settings
- > RF Output Power
- > **Security**
- > Access Control
- > WDS Settings
- > Site Survey
- > WPS
- > Schedule

## WDS Security Setup -wlan2

This page allows you setup the wireless security for WDS. When enabled, you must make sure each WDS device has adopted the same encryption algorithm and Key.

Encryption:

WEP Key Format:

WEP Key:

Pre-Shared Key Format:

Pre-Shared Key:

**Step 5.** After reboot, please go to “WLAN2 (2.4GHz) → Security” page to configure the repeater’s security setting for wireless clients. Select the encryption method and enter the security key. Then, click “Apply Changes”.

## Wireless Security Setup - WLAN2 (2.4GHz)

This page allows you setup the wireless security. Turn on WEP or WPA by using Encryption Keys could prevent any unauthorized access to your wireless network.

Select SSID:



**Encryption:**

**Authentication Mode:**  Enterprise (RADIUS)  Personal (Pre-Shared Key)

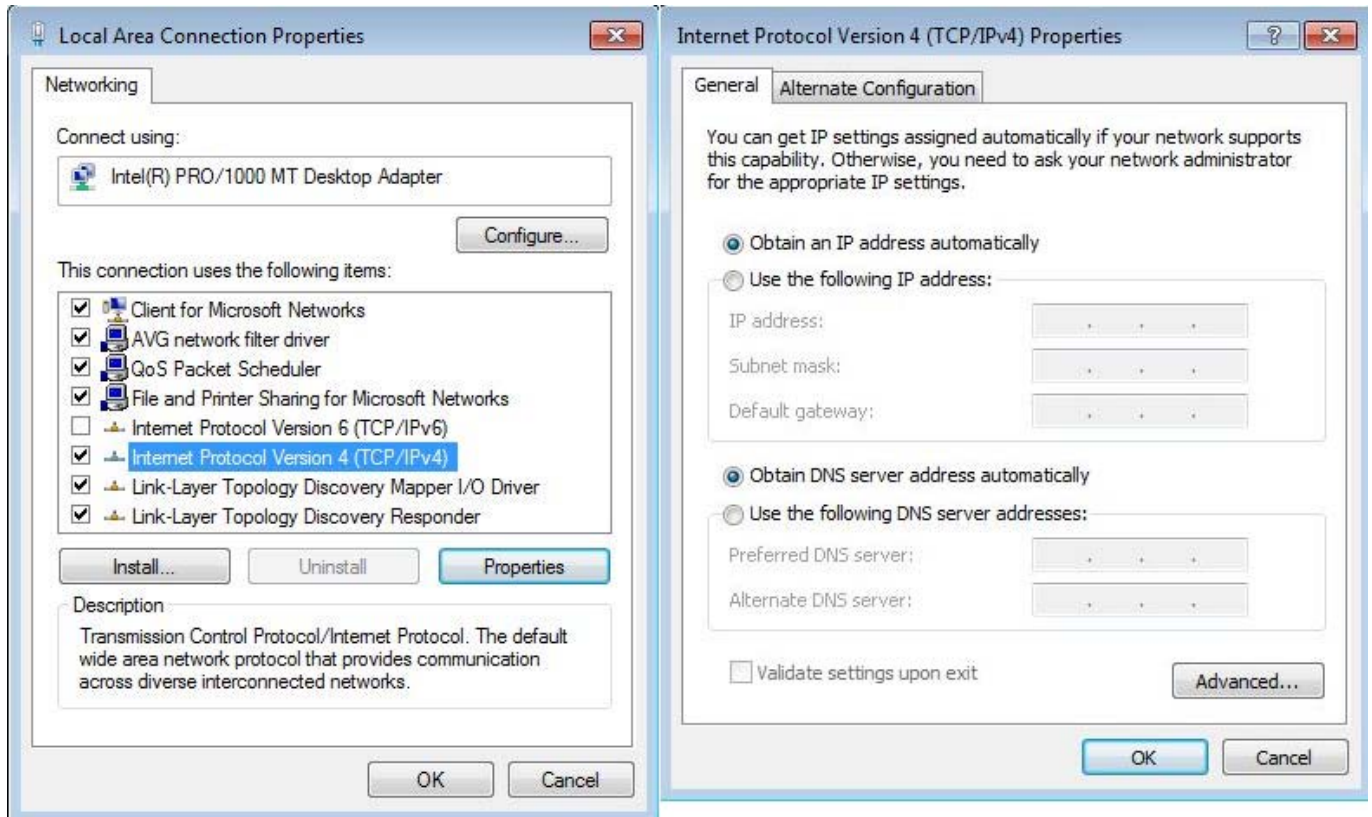
**Management Frame Protection:**  none  capable  required

**WPA2 Cipher Suite:**  TKIP  AES

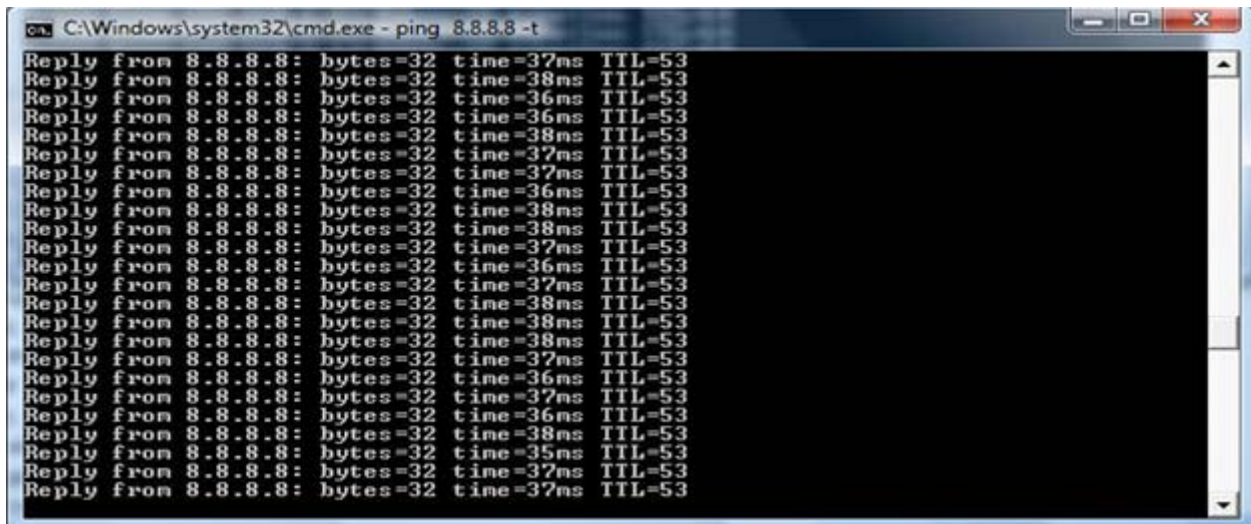
**Pre-Shared Key Format:**

**Pre-Shared Key:**

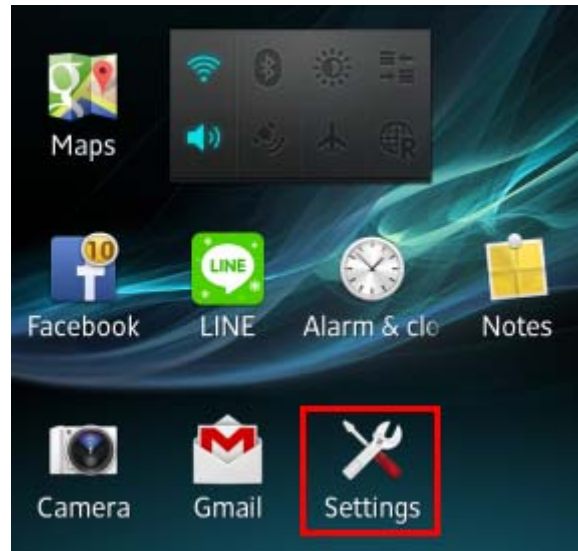
**Step 6.** In the laptop or PC connected to the WDAP-C7200AC-2 by Ethernet cable, go to TCP/IP settings to modify it to “Obtain an IP address automatically”.



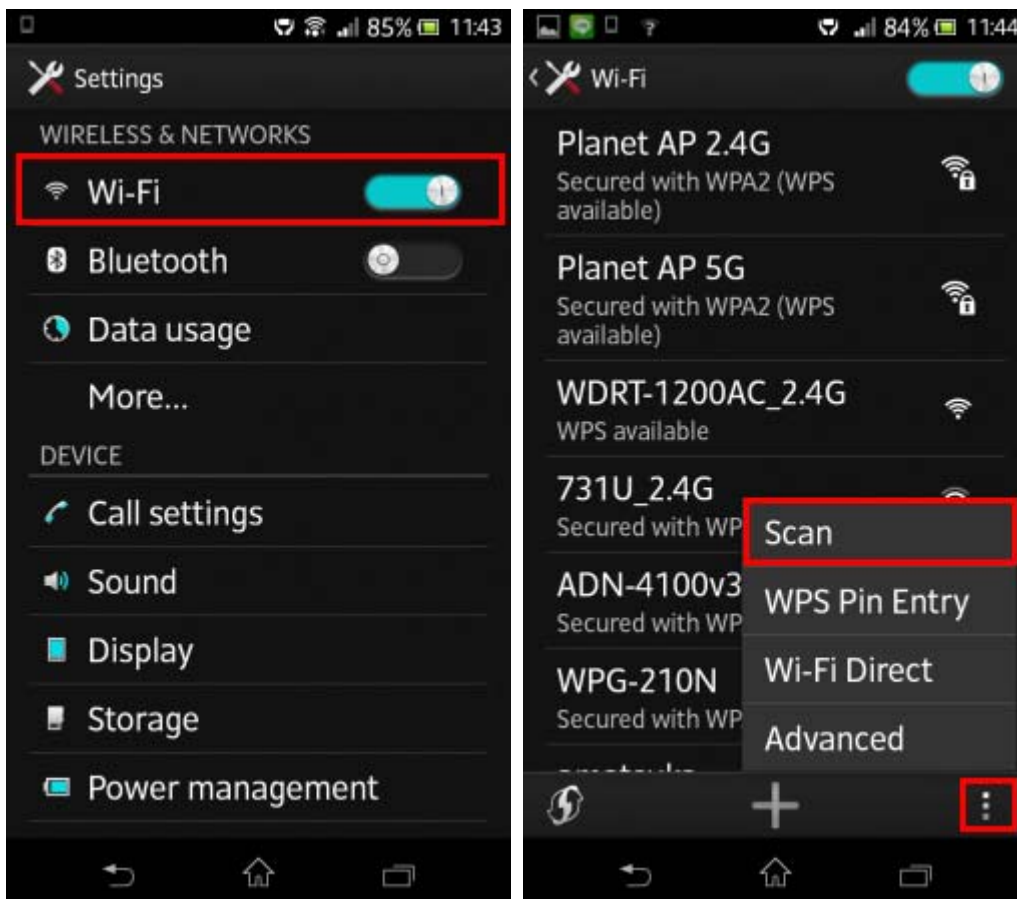
**Step 7.** Use the command line tool to ping the DNS (e.g. Google) to ensure the laptop or PC can access internet through the connection.



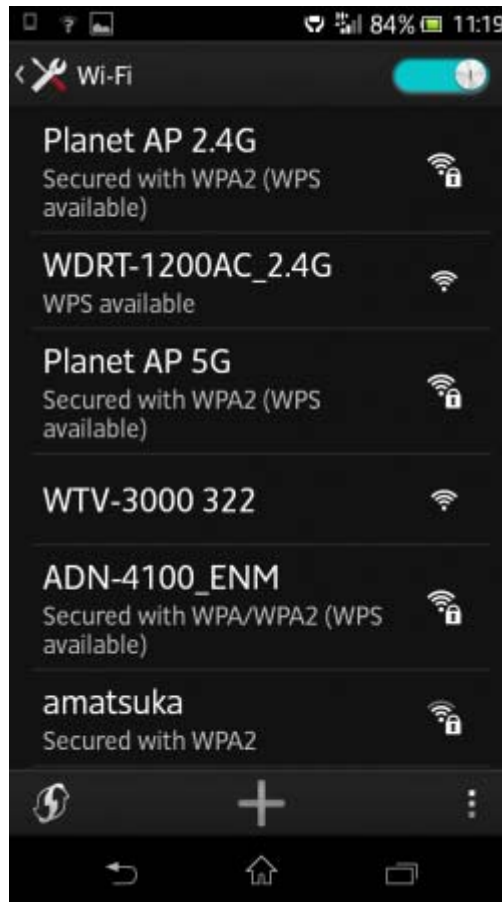
**Step 8.** In the Android Smart Phone, tap the [Settings] icon displayed in the home screen.



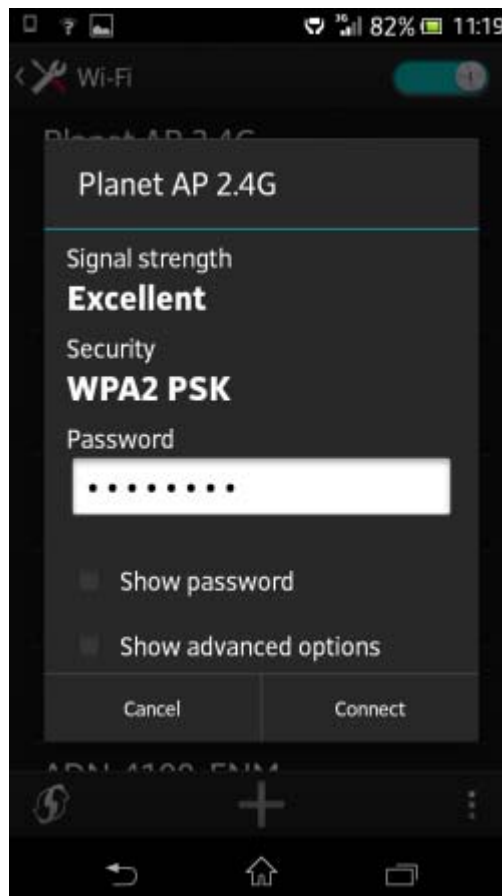
**Step 9.** Check Wi-Fi setting to view the available wireless network or tap the lower-right corner to re-scan the available wireless network.



**Step 10.** Tap the target wireless network (SSID).  
If you would like to connect to the WDAP-C7200AC using 5GHz frequency band, please select the SSID [**Planet AP 5G**]; in this case, we selected the SSID [**Planet AP 2.4G**].



**Step 11.** Enter the encryption key, and then tap [Connect].



**Step 12.** Check if the device is connected to the selected wireless network.



**Step 13.** Now, you should be able to surf internet on the laptop through the WDAP-C7200AC-2.



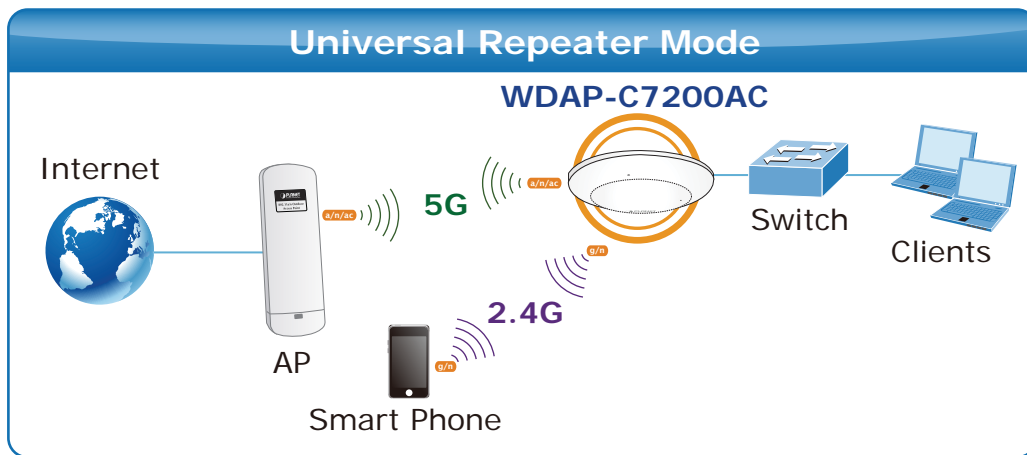
For the wireless connection setup in other platforms (e.g. iPhone, iPad, laptop), please refer to the **Chapter 6. Quick Connection to a Wireless Network.**



## Q2: How to set up the Universal Repeater Connection

In this case, we use 5GHz wireless to connect to the root AP and then repeat the wireless signal by using the 2.4GHz wireless interface to let the 2.4GHz wireless clients surf the internet.

### Topology:



1. Before configuration, please ensure the 5GHz root AP is already connected to the internet and the DHCP server is enabled to let it able to assign IP address to the connected clients.
2. Please ensure there is no IP conflict in the existing network. Otherwise, please re-configure the WDAP-C7200AC using other IP addresses which should be in the same network segment. The default IP address of the WDAP-C7200AC is [192.168.1.253](#).

**Step 1.** In the WDAP-C7200AC, go to “**WLAN1 (5GHz) → Basic Settings**” to configure wireless mode to “**AP**” and then check “**Enable Universal Repeater Mode (Acting as AP and client simultaneously)**”. Click “**Apply Changes**” to take effect.

### Wireless Basic Settings - WLAN1 (5 GHz)

Disable Wireless LAN Interface

Band:

Mode:

Network Type:

SSID:

Enable Mac Clone (Single Ethernet Client)


Enable Universal Repeater Mode (Acting as AP and client simultaneously)

SSID of Extended

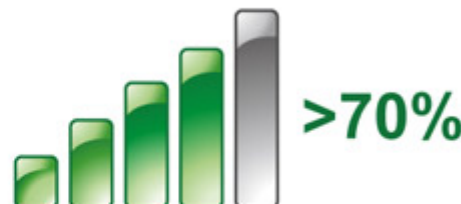
**Step 2.** Go to **5GHz Site Survey** (WLAN1 (5GHz) → Site Survey) page to find the root AP. Select the root AP that you want to repeat the signal and then click **“Next”**.

### Wireless Site Survey - WLAN1 (5GHz)


This page provides tool to scan the wireless network. If any Access Point or IBSS is found, you could choose to connect it manually when client mode is enabled.



Wireless Router



Recommended Signal Strength



Range Extender


SSID	BSSID	Channel	Type	Encrypt	Signal	Select
WDRT-1200AC-5G	00:30:4f:74:20:08	149 (A+N+AC)	AP	WPA2-PSK	67	<input type="radio"/>
Default_5G_1	00:30:4f:b4:c4:a8	157 (A+N)	AP	WPA2-PSK	30	<input checked="" type="radio"/>

**Step 3.** Select the correct encryption method and enter the security key. Then, click **“Connect”**.




## Wireless Site Survey - WLAN1 (5GHz)

This page provides tool to scan the wireless network. If any Access Point or IBSS is found, you could choose to connect it manually when client mode is enabled.




Wireless Router



>70%

Recommended Signal Strength



Range Extender

Encryption: WPA2 ▾

Authentication Mode:  Enterprise (RADIUS)  Personal (Pre-Shared Key)

WPA2 Cipher Suite:  TKIP  AES

Pre-Shared Key Format: Passphrase ▾

Pre-Shared Key: ●●●●●●●●

<<Back
Connect

**Step 4.** Check “Add to Wireless Profile” and click “Reboot Now”.

**Connect successfully!**

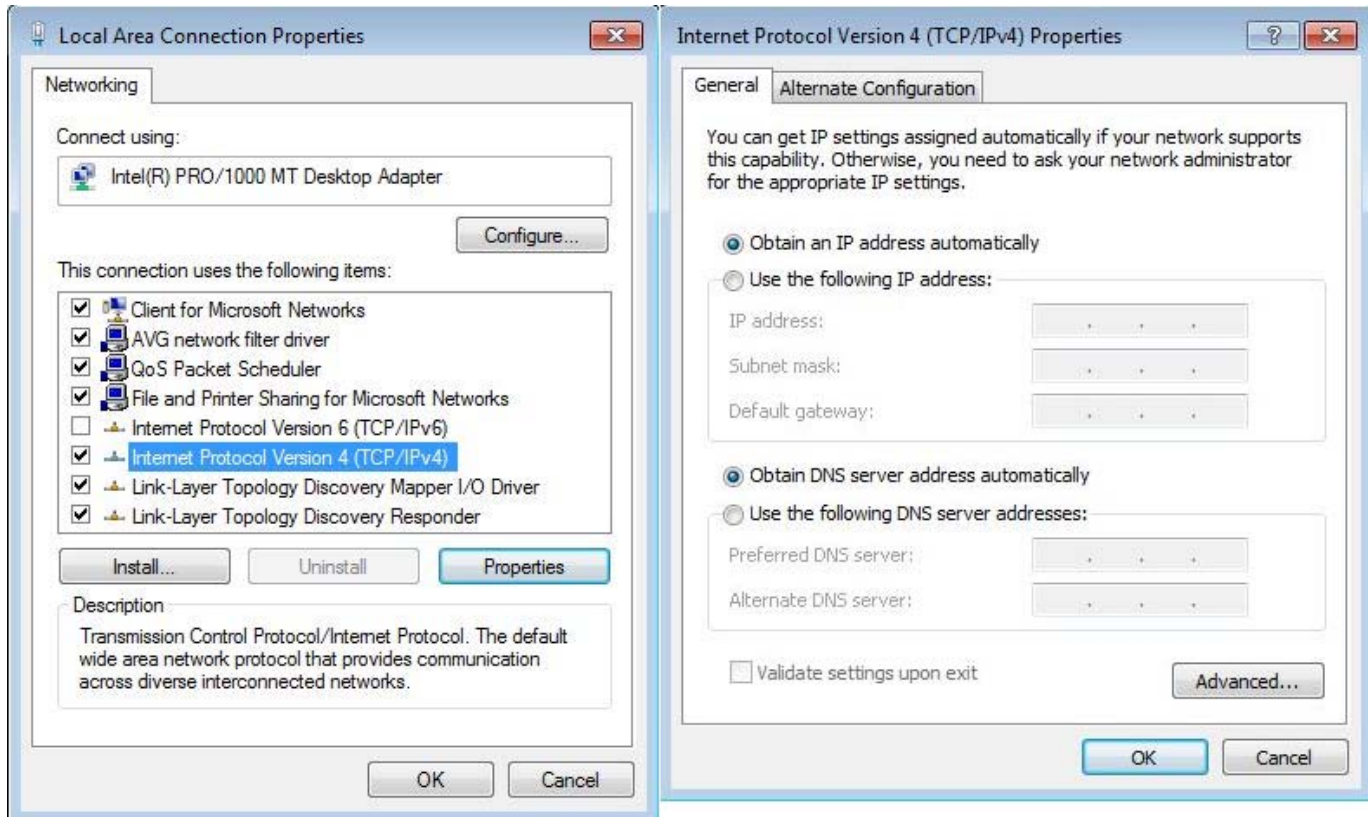
Add to Wireless Profile

Reboot Now
Reboot Later

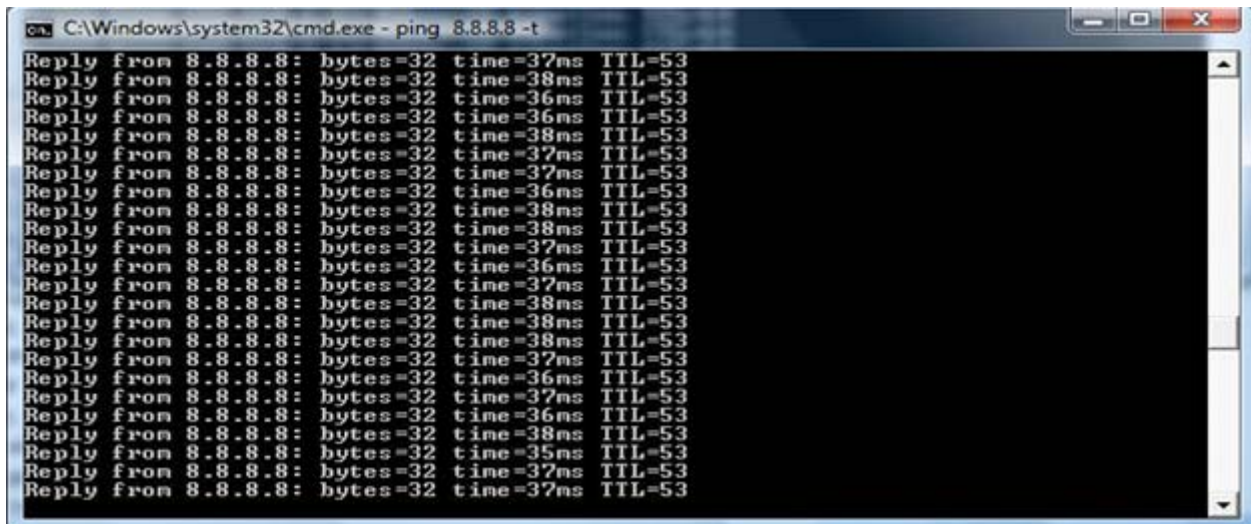
**Step 5.** Go to “Management-> Status” page to check whether the state of Repeater interface should be “Connected”.

Wireless 1 Repeater Interface Configuration	
Mode	Infrastructure Client
SSID	Default_5G_1
Encryption	WPA2
BSSID	00:30:4f:b4:c4:a8
State	Connected

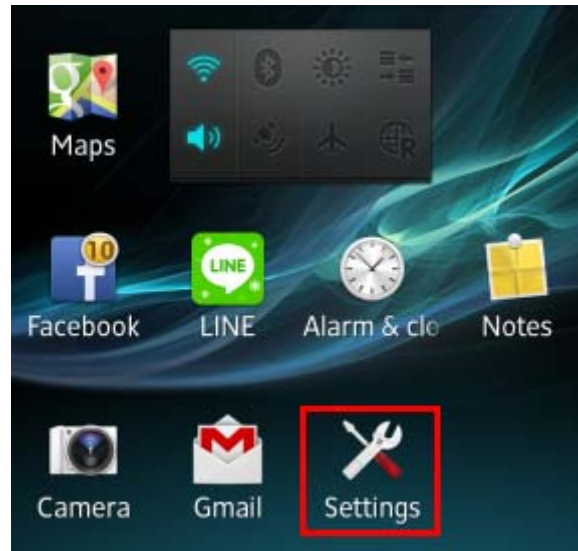
**Step 6.** In the laptop or PC connected to the WDAP-C7200AC by Ethernet cable, go to TCP/IP settings to modify it to “Obtain an IP address automatically”.



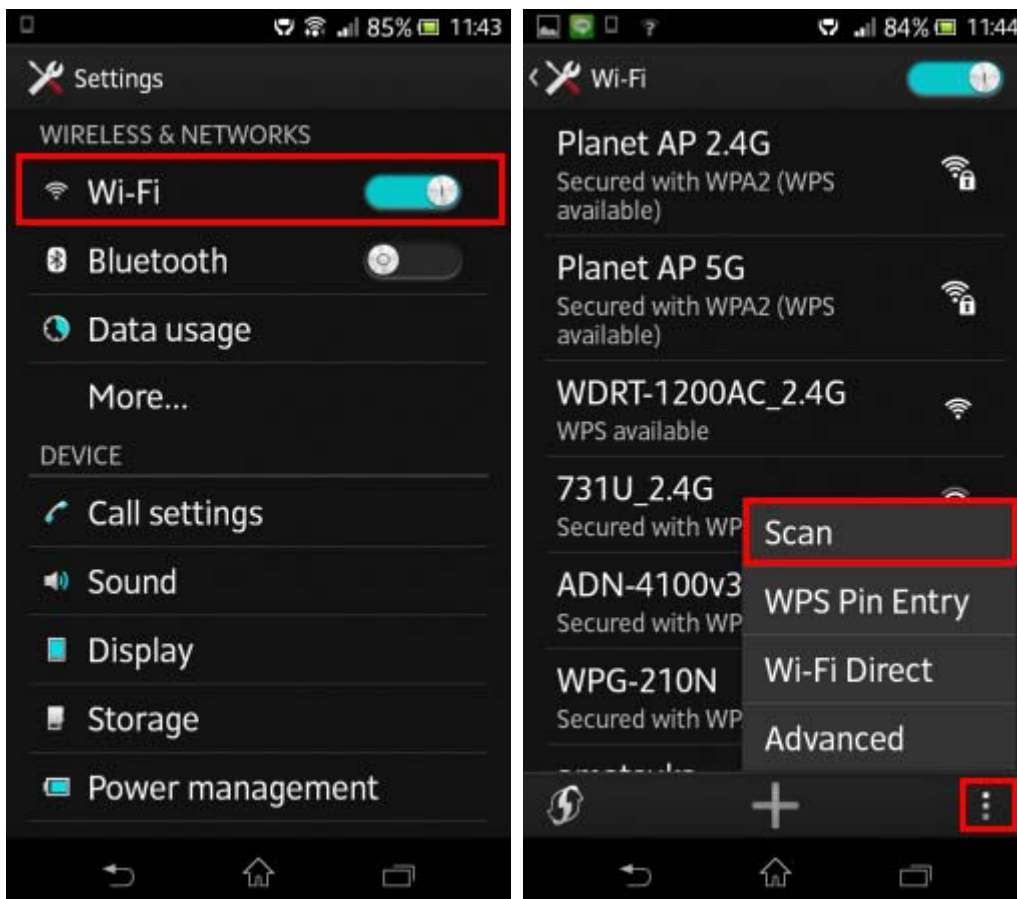
**Step 7.** Use the command line tool to ping the DNS (e.g. Google) to ensure the laptop or PC can access internet through the connection.



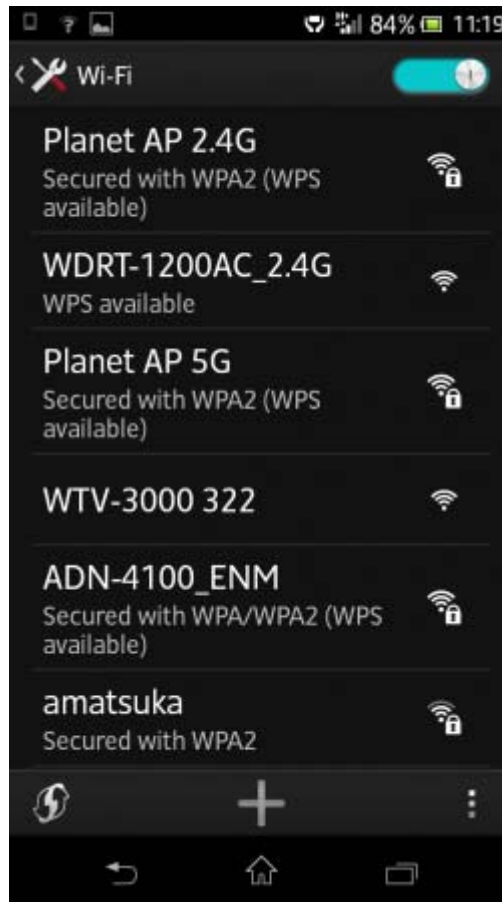
**Step 8.** In the Android Smart Phone, tap the [Settings] icon displayed in the home screen.



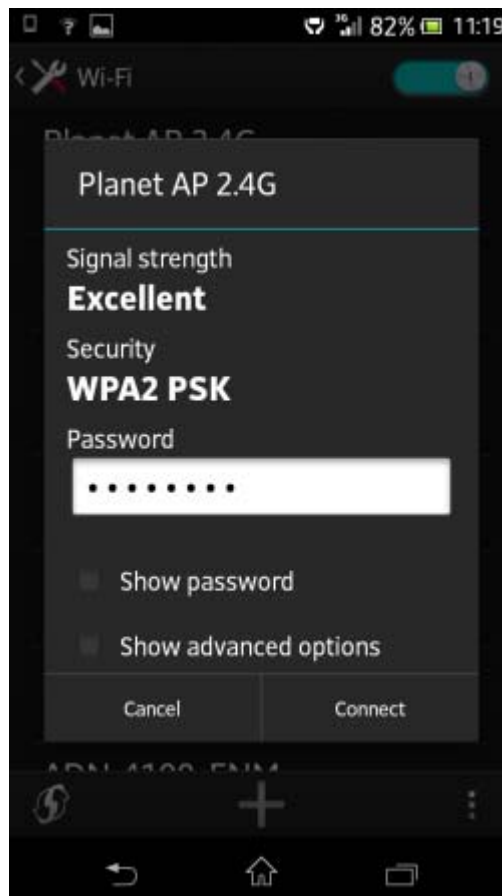
**Step 9.** Check Wi-Fi setting to view the available wireless network or tap the lower-right corner to re-scan the available wireless network.



**Step 10.** Tap the target wireless network (SSID).  
If you would like to connect to the WDAP-C7200AC using 5GHz frequency band, please select the SSID [**Planet AP 5G**]; in this case, we selected the SSID [**Planet AP 2.4G**].



**Step 11.** Enter the encryption key, and then tap [Connect].



**Step 12.** Check if the device is connected to the selected wireless network.



**Step 13.** Now, you should be able to surf internet on the laptop through the WDAP-C7200AC.



For the wireless connection setup in other platforms (e.g. iPhone, iPad, laptop), please refer to the **Chapter 6. Quick Connection to a Wireless Network.**



## Appendix B: Troubleshooting

If you find the AP is working improperly or stop responding to you, please read this troubleshooting first before contacting the dealer for help. Some problems can be solved by yourself within a very short time.

Scenario	Solution
The AP is not responding to me when I want to access it by Web browser.	<ul style="list-style-type: none"> <li>a. Please check the connection of the power cord and the Ethernet cable of this AP. All cords and cables should be correctly and firmly inserted into the AP.</li> <li>b. If all LEDs on this AP are off, please check the status of power adapter, and make sure it is correctly powered.</li> <li>c. You must use the same IP address section which AP uses.</li> <li>d. Are you using MAC or IP address filter? Try to connect the AP by another computer and see if it works; if not, please reset the AP to the factory default settings by pressing the 'reset' button for over 7 seconds.</li> <li>e. Use the Smart Discovery Tool to see if you can find the AP or not.</li> <li>f. If you did a firmware upgrade and this happens, contact your dealer of purchase for help.</li> <li>g. If all the solutions above don't work, contact the dealer for help.</li> </ul>
I can't get connected to the Internet.	<ul style="list-style-type: none"> <li>a. Go to 'Status' -&gt; 'Internet Connection' menu on the router connected to the AP, and check Internet connection status.</li> <li>b. Please be patient, sometimes Internet is just that slow.</li> <li>c. If you've connected a computer to Internet directly before, try to do that again, and check if you can get connected to Internet with your computer directly attached to the device provided by your Internet service provider.</li> <li>d. Check PPPoE / L2TP / PPTP user ID and password entered in the router's settings again.</li> <li>e. Call your Internet service provider and check if there's something wrong with their service.</li> <li>f. If you just can't connect to one or more website, but you can still use other internet services, please check URL/Keyword filter.</li> <li>g. Try to reset the AP and try again later.</li> <li>h. Reset the device provided by your Internet service provider too.</li> </ul>

	<ul style="list-style-type: none"> <li>i. Try to use IP address instead of host name. If you can use IP address to communicate with a remote server, but can't use host name, please check DNS setting.</li> </ul>
I can't locate my AP by my wireless device.	<ul style="list-style-type: none"> <li>a. 'Broadcast ESSID' set to off?</li> <li>b. Both two antennas are properly secured.</li> <li>c. Are you too far from your AP? Try to get closer.</li> <li>d. Please remember that you have to input ESSID on your wireless client manually, if ESSID broadcast is disabled.</li> </ul>
File downloading is very slow or breaks frequently.	<ul style="list-style-type: none"> <li>a. Are you using QoS function? Try to disable it and try again.</li> <li>b. Internet is slow sometimes. Please be patient.</li> <li>c. Try to reset the AP and see if it's better after that.</li> <li>d. Try to know what computers do on your local network. If someone's transferring big files, other people will think Internet is really slow.</li> <li>e. If this never happens before, call you Internet service provider to know if there is something wrong with their network.</li> </ul>
I can't log into the web management interface; the password is wrong.	<ul style="list-style-type: none"> <li>a. Make sure you're connecting to the correct IP address of the AP!</li> <li>b. Password is case-sensitive. Make sure the 'Caps Lock' light is not illuminated.</li> <li>c. If you really forget the password, do a hard reset.</li> </ul>
The AP becomes hot	<ul style="list-style-type: none"> <li>a. This is not a malfunction, if you can keep your hand on the AP's case.</li> <li>b. If you smell something wrong or see the smoke coming out from AP or A/C power adapter, please disconnect the AP and power source from utility power (make sure it's safe before you're doing this!), and call your dealer of purchase for help.</li> </ul>

## Appendix C: Glossary

- **802.11ac** - 802.11ac is a wireless networking standard in the 802.11 family (which is marketed under the brand name Wi-Fi), developed in the IEEE Standards Association process, providing high-throughput wireless local area networks (WLANs) on the 5 GHz band.
- **802.11n** - 802.11n builds upon previous 802.11 standards by adding MIMO (multiple-input multiple-output). MIMO uses multiple transmitter and receiver antennas to allow for increased data throughput via spatial multiplexing and increased range by exploiting the spatial diversity, perhaps through coding schemes like Alamouti coding. The Enhanced Wireless Consortium (EWC) [3] was formed to help accelerate the IEEE 802.11n development process and promote a technology specification for interoperability of next-generation wireless local area networking (WLAN) products.
- **802.11a** - 802.11a was an amendment to the IEEE 802.11 wireless local network specifications that defined requirements for an orthogonal frequency division multiplexing (OFDM) communication system. It was originally designed to support wireless communication in the unlicensed national information infrastructure (U-NII) bands (in the 5–6 GHz frequency range) as regulated in the United States by the Code of Federal Regulations, Title 47, Section 15.407.
- **802.11b** - The 802.11b standard specifies a wireless networking at 11 Mbps using direct-sequence spread-spectrum (DSSS) technology and operating in the unlicensed radio spectrum at 2.4GHz, and WEP encryption for security. 802.11b networks are also referred to as Wi-Fi networks.
- **802.11g** - specification for wireless networking at 54 Mbps using direct-sequence spread-spectrum (DSSS) technology, using OFDM modulation and operating in the unlicensed radio spectrum at 2.4GHz, and backward compatibility with IEEE 802.11b devices, and WEP encryption for security.
- **DDNS (Dynamic Domain Name System)** - The capability of assigning a fixed host and domain name to a dynamic Internet IP Address.
- **DHCP (Dynamic Host Configuration Protocol)** - A protocol that automatically configure the TCP/IP parameters for the all the PC(s) that are connected to a DHCP server.
- **DMZ (Demilitarized Zone)** - A Demilitarized Zone allows one local host to be exposed to the Internet for a special-purpose service such as Internet gaming or videoconferencing.
- **DNS (Domain Name System)** - An Internet Service that translates the names of websites into IP addresses.
- **Domain Name** - A descriptive name for an address or group of addresses on the Internet.
- **DSL (Digital Subscriber Line)** - A technology that allows data to be sent or received over existing traditional phone lines.
- **ISP (Internet Service Provider)** - A company that provides access to the Internet.



- **MTU (Maximum Transmission Unit)** - The size in bytes of the largest packet that can be transmitted.
- **NAT (Network Address Translation)** - NAT technology translates IP addresses of a local area network to a different IP address for the Internet.
- **PPPoE (Point to Point Protocol over Ethernet)** - PPPoE is a protocol for connecting remote hosts to the Internet over an always-on connection by simulating a dial-up connection.
- **SSID - A Service Set Identification** is a thirty-two character (maximum) alphanumeric key identifying a wireless local area network. For the wireless devices in a network to communicate with each other, all devices must be configured with the same SSID. This is typically the configuration parameter for a wireless PC card. It corresponds to the ESSID in the wireless Access Point and to the wireless network name.
- **WEP (Wired Equivalent Privacy)** - A data privacy mechanism based on a 64-bit or 128-bit or 152-bit shared key algorithm, as described in the IEEE 802.11 standard.
- **Wi-Fi** - A trade name for the 802.11b wireless networking standard, given by the Wireless Ethernet Compatibility Alliance (WECA, see <http://www.wi-fi.net>), an industry standards group promoting interoperability among 802.11b devices.
- **WLAN (Wireless Local Area Network)** - A group of computers and associated devices communicate with each other wirelessly, which network serving users are limited in a local area.

## EC Declaration of Conformity

<b>English</b>	Hereby, <b>PLANET Technology Corporation</b> , declares that this <b>11ac Wireless AP</b> is in compliance with the essential requirements and other relevant provisions of Directive 1999/5/EC.	<b>Lietuviškai</b>	Šiuo <b>PLANET Technology Corporation</b> ,, skelbia, kad <b>11ac Wireless AP</b> tenkina visus svarbiausius 1999/5/EC direktyvos reikalavimus ir kitas svarbias nuostatas.
<b>Česky</b>	Společnost <b>PLANET Technology Corporation</b> , tímto prohlašuje, že tato <b>11ac Wireless AP</b> splňuje základní požadavky a další příslušná ustanovení směrnice 1999/5/EC.	<b>Magyar</b>	A gyártó <b>PLANET Technology Corporation</b> , kijelenti, hogy ez a <b>11ac Wireless AP</b> megfelel az 1999/5/EK irányelv alapkövetelményeinek és a kapcsolódó rendelkezéseknek.
<b>Dansk</b>	<b>PLANET Technology Corporation</b> , erklærer herved, at følgende udstyr <b>11ac Wireless AP</b> overholder de væsentlige krav og øvrige relevante krav i direktiv 1999/5/EF	<b>Malti</b>	Hawnhekk, <b>PLANET Technology Corporation</b> , jiddikjara li dan <b>11ac Wireless AP</b> jikkonforma mal-ħtiġijiet essenzjali u ma provvedimenti oħrajn rilevanti li hemm fid-Direttiva 1999/5/EC
<b>Deutsch</b>	Hiermit erklärt <b>PLANET Technology Corporation</b> , dass sich dieses Gerät <b>11ac Wireless AP</b> in Übereinstimmung mit den grundlegenden Anforderungen und den anderen relevanten Vorschriften der Richtlinie 1999/5/EG befindet". (BMWi)	<b>Nederlands</b>	Hierbij verklaart , <b>PLANET Technology orporation</b> , dat <b>11ac Wireless AP</b> in overeenstemming is met de essentiële eisen en de andere relevante bepalingen van richtlijn 1999/5/EG
<b>Eestikeeles</b>	Käesolevaga kinnitab <b>PLANET Technology Corporation</b> , et see <b>11ac Wireless AP</b> vastab Euroopa Nõukogu direktiivi 1999/5/EC põhinõuetele ja muudele olulistele tingimustele.	<b>Polski</b>	Niniejszym firma <b>PLANET Technology Corporation</b> , oświadcza, że <b>11ac Wireless AP</b> spełnia wszystkie istotne wymogi i klauzule zawarte w dokumencie „Directive 1999/5/EC”.
<b>Ελληνικά</b>	<i>ΜΕ ΤΗΝ ΠΑΡΟΥΣΑ , <b>PLANET Technology Corporation</b>, ΔΗΛΩΝΕΙ ΟΤΙ ΑΥΤΟ <b>11ac Wireless AP</b> ΣΥΜΜΟΡΦΩΝΕΤΑΙ ΠΡΟΣ ΤΙΣ ΟΥΣΙΩΔΕΙΣ ΑΠΑΙΤΗΣΕΙΣ ΚΑΙ ΤΙΣ ΛΟΙΠΕΣ ΣΧΕΤΙΚΕΣ ΔΙΑΤΑΞΕΙΣ ΤΗΣ ΟΔΗΓΙΑΣ 1999/5/ΕΚ</i>	<b>Português</b>	<b>PLANET Technology Corporation</b> , declara que este <b>11ac Wireless AP</b> está conforme com os requisitos essenciais e outras disposições da Directiva 1999/5/CE.
<b>Español</b>	Por medio de la presente, <b>PLANET Technology Corporation</b> , declara que <b>11ac Wireless AP</b> cumple con los requisitos esenciales y cualesquiera otras disposiciones aplicables o exigibles de la Directiva 1999/5/CE	<b>Slovensky</b>	Výrobca <b>PLANET Technology Corporation</b> , týmto deklaruje, že táto <b>11ac Wireless AP</b> je v súlade so základnými požiadavkami a ďalšími relevantnými predpismi smernice 1999/5/EC.
<b>Français</b>	Par la présente, <b>PLANET Technology Corporation</b> , déclare que les appareils du <b>11ac Wireless AP</b> sont conformes aux exigences essentielles et aux autres dispositions pertinentes de la directive 1999/5/CE	<b>Slovensko</b>	<b>PLANET Technology Corporation</b> , s tem potrjuje, da je ta <b>11ac Wireless AP</b> skladen/a z osnovnimi zahtevami in ustreznimi določili Direktive 1999/5/EC.
<b>Italiano</b>	Con la presente , <b>PLANET Technology Corporation</b> , dichiara che questo <b>11ac Wireless AP</b> è conforme ai requisiti essenziali ed alle altre disposizioni pertinenti stabilite dalla direttiva 1999/5/CE.	<b>Suomi</b>	<b>PLANET Technology Corporation</b> , vakuuttaa täten että <b>11ac Wireless AP</b> tyyppinen laite on direktiivin 1999/5/EY oleellisten vaatimusten ja sitä koskevien direktiivin muiden ehtojen mukainen.
<b>Latviski</b>	Ar šo <b>PLANET Technology Corporation</b> , apliecinu, ka šī <b>11ac Wireless AP</b> atbilst Direktīvas 1999/5/EK pamatprasībām un citiem atbilstošiem noteikumiem.	<b>Svenska</b>	Härmed intygar, <b>PLANET Technology Corporation</b> , att denna <b>11ac Wireless AP</b> står i överensstämmelse med de väsentliga egenskapskrav och övriga relevanta bestämmelser som framgår av direktiv 1999/5/EG.

## EC Declaration of Conformity

For the following equipment:

\*Type of Product: 1200Mbps 802.11ac Dual Band Ceiling Mount Wireless Access Point

\*Model Number: WDAP-C7200AC

\* Produced by:

Manufacturer's Name : **Planet Technology Corp.**

Manufacturer's Address: 10F., No.96, Minquan Rd., Xindian Dist.,  
New Taipei City 231, Taiwan (R.O.C.)

is herewith confirmed to comply with the requirements set out in the Council Directive on the Approximation of the Laws of the Member States relating to 1999/5/EC R&TTE, Low Voltage Directive 2006/95/EC.

For the evaluation regarding the R&TTE the following standards were applied:

EN 55022	(2010/AC:2011)
EN 61000-3-2	(2006+A1:2009+A2:2009)
EN 61000-3-3	(2013)
EN 55024	(2010)
EN 61000-4-2	(2009)
EN 61000-4-3	(2006+A1:2008+A2:2010)
EN 61000-4-4	(2012)
EN 61000-4-5	(2006)
EN 61000-4-6	(2009)
EN 61000-4-11	(2004)
EN 300 328 V1.8.1	(2012)
EN 301 893 V1.7.1	(2012)
EN 301 489-17 V2.2.1	(2012)
EN 301 498-1 V1.9.2	(2011)
EN 60950-1(2006 + A11: 2009 + A1:2010 + A12:2011)	

Responsible for marking this declaration if the:

Manufacturer       Authorized representative established within the EU

Authorized representative established within the EU (if applicable):

Company Name: **Planet Technology Corp.**

Company Address: **10F., No.96, Minquan Rd., Xindian Dist., New Taipei City 231, Taiwan (R.O.C.)**

Person responsible for making this declaration

Name, Surname      **Kent Kang**

Position / Title :      **Product Manager**

Taiwan  
Place

24 Dec., 2014  
Date

  
Legal Signature

**PLANET TECHNOLOGY CORPORATION**